

# VINTAGE RADIO

By Associate Professor Graham Parslow



## Astor 1952 Hybrid GP/PS Portable Radio



Astor's hybrid portable is a combination of the model GP's case with the later model PS circuit. It incorporates an RF preamplifier stage for excellent sensitivity, which is crucial for a portable radio. It's also notable for its 8-inch loudspeaker; quite large for a portable.

Sir Arthur Warner was a giant in the history of Australian radio. In 1922 he became a partner in a small Melbourne basement store that imported telephone equipment and radio parts. The outlet was the beginning of an industrial and commercial empire, best known by the Astor brand name.

Warner became chairman and managing director of Electronic Industries Ltd (Astor) in 1939. He died aged 67 in 1966, but packed what looks like ten lifetimes of parliamentary and industrial achievements into his time. Warner's Australian Dictionary of Biography entry can be read at [siliconchip.com.au/link/aaaj](http://siliconchip.com.au/link/aaaj)

Sir Arthur merits a mention because he was famed for his approach to containing costs and minimising waste. If Astor had a stock of 10k $\Omega$  resistors they would be used in a radio circuit

that may have specified 20k $\Omega$  (as long as they worked).

The radio shown here looks like the Astor model GP introduced in 1948 but it is clearly date-stamped "21 FEB 1952". In 1952 the current Astor portable radio model was the PS which did away with the former discrete speaker grille fabric and used a moulded PVC mesh, integrated with the case.

Incidentally, this case is not Bakelite but is thermoplastic (thermosoftening plastic). Because of this, heat generated from the internal components has caused quite apparent distortion.

But Sir Arthur apparently had some GP model cases that he was reluctant to discard, so this radio is a hybrid of the model GP case and the model PS circuit. Even so, his frugality did not mean cutting the quality of the components. For example, the speaker

transformer in this radio is a large, high quality unit paired with the best speaker available at the time.

Why was it so easy to create such a hybrid? Again, it was a matter of being economical. The metalwork of this chassis is identical to other Astor portables, dating from the timber-cased 1946 model KP. In 1955 the metalwork for Astor valve portables was changed to support knobs on the front face.

Everything in this radio's circuit is true to the Astor model PS. It is a high-performance radio with an RF preamplifier stage.

This is immediately apparent from the three-gang tuning capacitor and is also indicated by the number 6 on the ARTS&P licensing decal (radios without an RF stage were licensed with number 5).

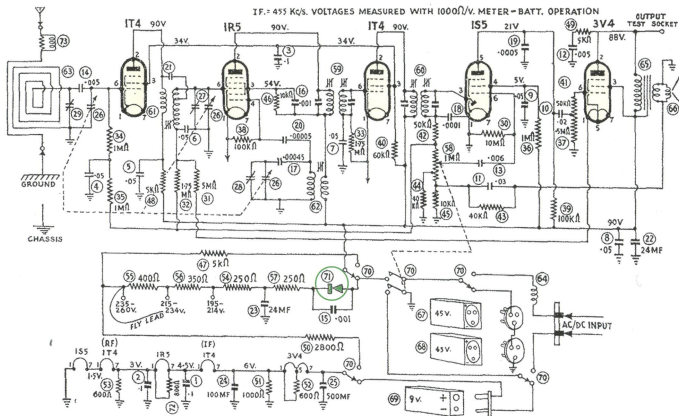

The Astor circuit has an number of interesting aspects such as the RF preamplifier (important for a portable set) and a tapped volume control to give a loudness effect (bass boost at low volume settings). But the ability to use 240VAC mains instead of batteries was a cheap and nasty approach since no power transformer was provided. Diode #71, highlighted in green, is a selenium rectifier stack.

## Circuit details

The circuit starts with the internal loop aerial that is lattice wound on a plastic former, characteristic of a decade of Astor radios. Unlike the preceding model GP, the PS circuit has external aerial and earth connections terminating in sockets in the middle of the plastic lattice aerial former. The sockets are accessible from the back of the case.

The loop aerial is easily detached from the chassis by removing two screws. However, the connecting wires are short and it is not practical to work on the set until longer wires are patched in so the aerial can be moved further away on the bench. Fortunately, the tether to the 8-inch speaker is long enough to leave the original wiring in place.

By 1952 almost every Australian manufacturer of valve portables was using the same valve line-up as in this radio. RF preamplification is provided by a 1T4 pentode fed by the first tuned circuit, comprising the aerial coil and tuning capacitor.

As in many portables, there is no

dial cord in this radio but a reduction gear allows the tuning knob to rotate through 270° while the tuning capacitor shaft rotates through 180° to provide easy and precise station selection.

The output of the 1T4 pentode is fed to the control grid, pin 6, of the 1R5 mixer-oscillator. Its grid bias is set by the AGC voltage derived from the diode in the 1S5 valve.

Since all the valves in this circuit have directly-heated cathodes, the overall grid-cathode bias for each valve is the difference between the grid potential (typically close to 0V) and the individual positive cathode voltage (between 0V and 9V) provided by the series heater string from the LT 9V battery.

The transformer coupling the RF stage to the 1R5 is housed in a square section aluminium can identical to the subsequent IF transformers (all three cans are on top of the chassis). The small local oscillator coil is under the chassis, close to the 1R5 valve, and feeds into pin 4 of the 1R5.

The intermediate frequency is

455kHz and the circuitry around the 1T4 IF amplifier is conventional.

The 1S5 diode-pentode demodulates the RF signal (the diode's anode is at pin 3) and the resulting audio appears across the 1M $\Omega$  potentiometer and is fed to the control grid of the pentode section at pin 6. So the pentode in the 1S5 functions as an audio preamplifier.

The DC component of the demodulated audio signal to the volume control also becomes the AGC voltage to be fed back to the grid of the 1T4 RF preamplifier and the 1R5 mixer-oscillator.

## Loudness control

The output from the audio preamplifier's plate is fed to the grid of the 3V4. This pentode drives the single-ended transformer-coupled output stage and loudspeaker. Negative feedback is applied from the transformer's secondary winding to the bottom end of the 1M $\Omega$  volume control potentiometer.

But the main reason for this feedback is not to simply reduce harmonic distortion in the preamplifier and out-

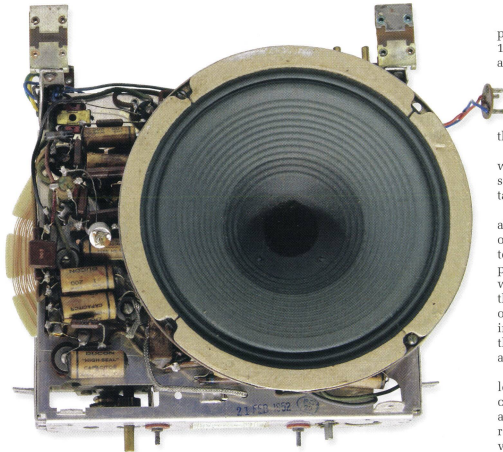

The original 8-inch, 13Ω loudspeaker in the set is in very good condition.

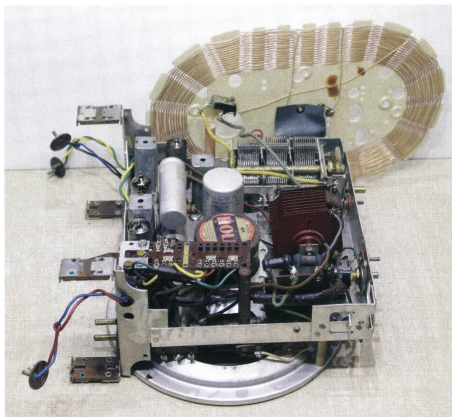

This view of the chassis reveals the two brass prongs (lower left-hand corner) for the 240VAC input. That multi-pole switch in the foreground has live 240VAC present when the mains voltage is applied.

put stages. Have another look at the 1MΩ volume control (#58) which has a tap on it connected to the chassis via a 40kΩ resistor (#43). This provides a degree of bass boost at low volume settings, ie, when the wiper is on the section of the element between the fixed tap and chassis.

In a normal loudness circuit you would expect to find a capacitor in series with the 40kΩ resistor from the tap connection.

So how does the bass boost come about? That appears to be a function of the negative feedback connection to the bottom of the volume control potentiometer and its interaction with the .03μF capacitor shunting the 40kΩ feedback resistor from the output transformer's secondary winding. Backing up this notion is the fact that the 40kΩ/.03μF RC network has a +3dB corner frequency at 100Hz.

In any case, it is unusual to find a loudness control in a valve radio circuit, particularly a portable set such as this one. Loudness controls were reasonably common in higher-end valve radios and stereo amplifiers but typically they did not provide loudness compensation at low volumes (ie, bass and treble boost) but bass boost only.

The 3V4 output valve is capable of sending 250mW of audio to the speaker. This is fine for most listening situations when coupled with the high-efficiency Rola model 8M speaker.

## AC & DC supplies

In common with many portable radios of the day, this Astor portable could be run from its batteries or the 240VAC mains supply. In fact, this radio can work from high voltage AC or DC mains, as well as batteries.

Two 45V batteries provide the 90V high tension rail and a 9V battery provides current to the series connected valve filaments, as shown on the circuit diagram. A switch accessible at the bottom selects battery or mains power. On-off is linked to the volume control.

However, while other portables of the time usually had a mains transformer, this set is transformerless and that means that, depending on the house wiring and the wiring of the input plug, the chassis could be operating at the full 240VAC potential.

In other words, if you have access to the chassis for repairs or alignment,

you are working in a potentially lethal situation. In this situation, you really should connect the set via an isolation transformer.

The mains input socket is at the bottom of the case and as can be seen there is no possibility of polarisation (both pins are the same) and if there were, that would not prevent the chassis from becoming live if the Active and Neutral wires were swapped.

The incoming mains supply is fed to a selenium rectifier stack, ie, it is a half-wave rectifier. The stack comprises ten elements meaning that any single element rectifies only 24V AC. This is close to the peak inverse voltage limit of selenium diodes.

The DC produced by the selenium rectifier (when new) would have been about 270V, allowing for the 5V or so of forward voltage drop for each element in the stack. That voltage is then progressively reduced by a series of wirewound resistors to produce the 90V HT and a further dropping resistor to produce the 9V for the series-connected directly-heated cathodes of the five valves.

Selenium rectifiers were a significant improvement on valve rectifiers when they were introduced, especially in portables because they needed no heater current and their forward voltage is considerably less than a valve diode at the same current. However, once silicon power diodes were introduced, they quickly rendered selenium rectifiers obsolete.

*Editor's note: regardless of which way you look at it, the mains input to this portable set is dangerous. Apart from the chassis having high voltages present, if the mains is applied and the radio is turned on with the 3V4 valve out of its socket, the voltage across all the electrolytic filter capacitors in the circuit will be quite high and will probably cause immediate failure.*

*The selenium rectifier in a 66-year old circuit would also be suspect and likely to fail, with the risk of fire. We would strongly recommend that the 240VAC terminals in the recessed socket be removed to avoid any possibility that someone might attempt to power the set from the mains.*

## The restoration

This radio was purchased some time ago at an auction and had been stored on an upper shelf in a shed for some years.



Before restoration the cabinet was in an unkempt state with a tear in the plastic at the lower left-hand corner.

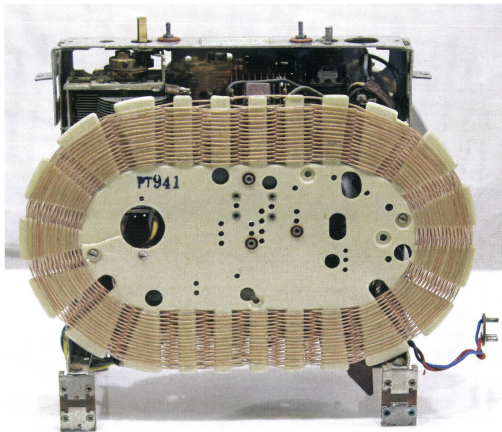

The lattice-wound loop aerial gives good signal pickup. External antenna connections are provided on the rear of the cabinet.

Then a possum discovered that she could nest with her joey a bit further along that shelf on a comfortable mat of bubble wrap and other packaging. The possum entered by way of a small gap between the wall and roof that led to the shelf. I decided to be tolerant at first; after all, they looked so cute.

Then the radio was knocked off the shelf but it fortunately had a soft landing. Then possum smells became evident and other objects were dislodged, as the possum explored the environment.

Enough was enough; the hole was blocked. Rather than put the set back

on the shelf, I decided that it was the next candidate for restoration.

The cabinet was quite grubby and had a tear in the plastic at the lower left corner. This was patched with Araldite and a missing Astor swan badge was replaced from my spares bin.

The aluminium base-plate had been corroded by batteries left in the radio probably decades ago. After a thorough clean the plate was painted with acrylic silver paint to make it presentable. Little of that plate is normally seen anyway.

Removing the chassis is straight forward. The knobs at the top are removed by loosening grub screws. The yellow plastic dial plate requires only two nuts that hold it to the chassis to be removed. Then two screws at the sides of the chassis can be removed to let the chassis slide out.

All the components looked intact. The first operation was to clean the pins of each valve. Experience has shown that with near certainty one or more valves in portables will not function due to pin-socket corrosion (oxide-creep).

Bench power supplies were hooked

up to the battery plugs. A good sign was that the 9V supply drew 52mA, indicating good connection of the series-connected valve filaments.

Ramping up the high tension initially showed much higher current than expected, but the current decreased with time. This was due to the electrolytic filter capacitors reforming their dielectric layer.

After some time the voltage reached 90V at 5mA but the radio was dead. The current should have been close to 10mA.

Using a signal tracer to check for tuned stations at the volume control produced an absolute zero. Both the RF and audio sections were dead. So I focused my attention on the audio section and fortunately, the speaker and output transformer checked OK.

I then found that the 20nF coupling capacitor from the 1S5's plate was leaky and this brought the 3V4 grid to +20V.

Normally this would cause excessive current drain on that stage but oddly, the HT current drain remained low after the capacitor was replaced, bringing the 3V4's grid back to 0V.

(In fact, as shown on the circuit, the series heater connections mean that the negative bias to the 3V4 grid is arrived at because the directly heated cathode is connected to the positive terminal of the 9V battery connection, ie, the grid is -9V with respect to the cathode.)

Audio from a signal generator now came through the speaker when injected into the 3V4's grid (pin 6) but nothing came through when audio was injected into the 1S5 diode or grid.

Pin 4, the screen of the 1S5 measured 11V instead of the 5V shown on the circuit although I will come back to that point. The 50nF screen decoupling capacitor was found to be leaky and the screen voltage limiting resistor was around 10M $\Omega$ ; not 1M $\Omega$  as shown on the circuit.

Replacing the defective resistor and capacitor restored function in the 1S5 and signal injected at the 1S5 diode now responded to the volume control as expected. So the audio section was now functioning.

## Voltage measurements

Now back to that point about the voltage on the screen of the 1S5. All the voltages shown on the circuit are

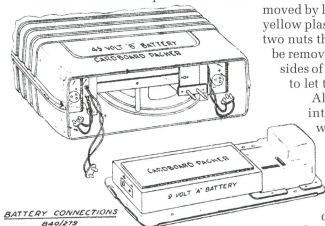

These two views of the underside of the show the battery compartment and the chassis base-plate together with the recessed 2-pin socket for the 240VAC mains input. The cover for the socket is missing.

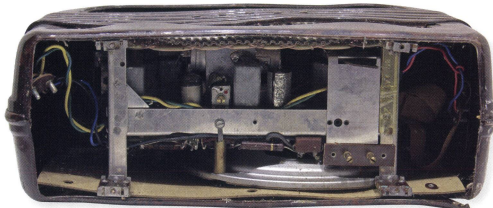

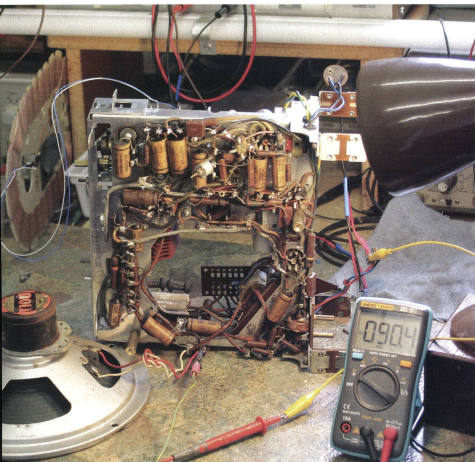

Most of the wax-impregnated paper capacitors on the unrestored chassis (above) needed to be replaced due to high leakage. A few of the carbon resistors had also gone high in value and so were replaced. Since there's no power transformer, the chassis can become live if the Active and Neutral connections are swapped.

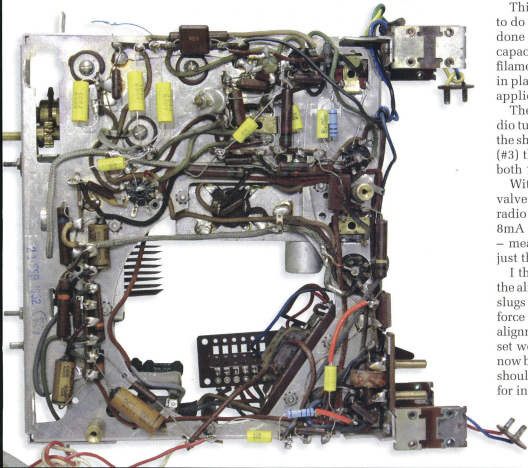

what would have been found with 1000 ohms/volt meter.

Such a low meter sensitivity was normal in those days but the screen voltage was actually much higher, even after allowing for the very small screen current that would normally flow. In fact, measurement with a modern digital multimeter with an input resistance of 10M $\Omega$  gave a value of 50V.

While the audio stages were now working, there was still no RF output. All plate voltages were correct except the 1T4 preamplifier valve which was sitting at 9V, not 90V.

The 50nF capacitor shown as component 5 was down to 30 $\Omega$  and was pulling the HT low. Fortunately the 5k $\Omega$  decoupling resistor (#48) survived being shorted to earth. The plate came back to 90V with a replacement capacitor.

Then the first IF transformer (#59) was found to have an open-circuit secondary. It was replaced from an Astor chassis I had on the spares shelf. The associated 50nF capacitor and 1.75M $\Omega$  resistor were also replaced; the resistor had gone high in value.

A signal generator injecting modulated 455kHz still did not produce any detectable output on an oscilloscope along the chain of RF components.

This was baffling until I decided to do what I probably should have done earlier and replace all paper capacitors in the main circuit (the filament circuit capacitors were left in place as they have less than 10V applied to them).

The final key to restoring the radio turned out to be replacement of the short-circuited 100nF capacitor (#3) that decouples the screens of both 1T4 valves.

With no screen voltage both 1T4 valves were dead. After that, the radio worked as it should, drawing 8mA @ 90V. My take-home lesson – measure all valve voltages, not just the plates.

I then set the radio up to check the alignment. However, the tuning slugs did not move under moderate force and rather than persist, the alignment was abandoned. Still, the set works reasonably well and has now been moved to a display shelf. I should probably thank the possums for initiating the restoration. **SC**