

605 v. 2-3

electronics

A MCGRAW-HILL PUBLICATION

New York, January, 1931



O. H. CALDWELL
Editor

FRANKLIN S. IRBY, Ph. D.
Associate Editor

KEITH HENNEY, M.A.
Associate Editor

1930—and 1931

NINETEEN-THIRTY was a year of many disappointments to the business world, but it was a year of marked advances in the fields of electronic developments. Above all it was a year in which an increasing number of groups and industries became "electronics conscious"—that is, came to recognize the common interest and common problems of their widely diversified activities. This new alignment of new and older arts under the common denominator of electronic principles promises even more rapid advance for the future.

Looked at for its own definite achievements in the electron arts, 1930 was a surprising year. A roll-call of the past twelve months brings out a remarkable list of practical accomplishments:

. . . Regular telephone service between Australia and the United States; synchronizing of broadcasting stations; dependable international broadcasting; two-way phone-booth television; theater-scale television; direct-current high-tension transmission; 400-kw. broadcasting; the arc loud-speaker; low-drain radio tubes; the air-cell battery; more compact radio receiving sets; automobile radios, airplane fog-landing beacons; hot-cathode neon-tube lighting; high-frequency fields applied to artificial fevers; the electronic crystal-controlled clock; home "talkies," elimination of ground noise in motion-picture films; beam-microphone recording; portable public-address systems; giant X-ray tubes operating up to 700,000 volts; safety and industrial uses of electron tubes and photo-cells, the ultra-violet dosage meter, electronic musical instruments, and so on.

WITH such a record of achievement for the twelve months just closed, certainly one can look ahead to 1931 with confidence and enthusiasm. The year now begun will be a year of equivalent technical accomplishment. Of that there can be no doubt. When the list is written twelve months hence, an equal number of now-unexpected miracles will be found ready to be chronicled. The *scientific* expansion of the electronics field is assured.

But 1931 promises above all else to be a year when *commercial* development will go ahead, *all along the line* of the electronic arts, including radio and sound pictures. New industries will be founded, businesses will be expanded. Economic problems rather than scientific difficulties will be faced. There will be questions of business organization, management, raw materials, purchases, production methods, costs, plant efficiency, sales planning.

HAND in hand with scientific discovery, must now come the commercial expansion on which sound and prosperous electronic industries will be based.

The year 1931 will make electronic history—in research, in invention, in business. It will usher in a new commercial era of electronics, putting new electron industries on the business map. It will mark the start of the wide expansion and universal usefulness which the electronic industries are destined to enjoy.

S AND FUTURE TRENDS

least three manufacturers in this country and two in Canada, and probably more will use the variable-mu tube (the 551-type). The number of tubes needed will be in the neighborhood of a half million, many of which will be made by Majestic for use in their own product.

Midgets will lead in unit sales

The midget of 1931 will probably sell at retail in the neighborhood of \$55, will make up perhaps 60 per cent of all unit sales in 1931, and will be technically improved. So much for the midget.

The next important class of merchandise will be the console selling around \$125 and will probably represent a high-water mark in the quantity of merchandise the consumer gets for his money. About 30 per cent of the unit sales will be made up from this group. Many of these sets will be not only radio but phonograph as well, which is one way of utilizing a given amount of cabinet money most efficiently. Improvements in midgets may overflow into this group. It is certain that any money-saving idea will not go begging.

A few of these \$125-class receivers will have automatic phonographs in them. At any rate the next class will have them and, in spite of rather general pessimism regarding phonograph combinations or even automatic, may do well. A great part of the South is still uncovered with signals that can compete with static through the major part of the year. It is a part of the country where love of music is probably greater than in sections more favored with field strength.

Combination sets

The third class of receivers to be sold will be the expensive combination, probably with automatic record changing, home recording and many other devices to make the instrument a source of endless entertainment for the proud owner.

Manufacturers in general, state that little business has been or is to be done in the combination line. Perhaps this is true, but there is a strong chance that the lazy listening public will take to the automatic where he would not operate a phonograph. Perhaps a string of 50-kilowatt stations putting down good field strengths in all parts of the United

States will permanently anaesthetize the combination market. Certain it is that the public is becoming less and less inclined to work for its entertainment. The less effort required to extract music from the air the more the public will like it. Perhaps the automatic phonograph will awaken this sleeping market.

Circuit developments

The superheterodyne was the circuit advance of 1930. In 1931 it will continue to hold center of attention. In the opinion of many engineers the superheterodyne is the circuit par excellence, theoretically at least. Screen-grid intermediate amplifiers with exceptionally high gain, and band-pass filters will enhance their value to the user, 1931 will see many thousands of superheterodynes built and sold.

Farm, office, automobile radios

Introduction of the Eveready 2-volt battery and increased experience in manufacturing the 2-volt tubes announced in June will no doubt stimulate the production of receivers for farm areas. In general the feeling is

that while difficulties with the 2-volt tubes may be ironed out in the future they are as yet not fool-proof nor do they deliver sufficient loud speaker power to satisfy the listener. One enterprising manufacturer is using a pentode power tube with consequent increase of power output, even if, as the scoffers say, the fidelity is impaired somewhat.

Automobile sets will be pushed much harder in 1931. Technical economies learned in midget manufacture will reduce the price generally to about \$100 or below and make the set into a useful accessory for the car. If this price can be brought to \$60-\$70 (not installed) an enormous stimulus to sales will be provided.

Quoting M. H. Aylesworth, president National Broadcasting Company, "The majority of business men will have radio sets in their offices in 1931 because of program importance." Material broadcast for the specific interest of business men will encourage appearance and sale of radios for offices, housed in furniture resembling other office equipment such as the typewriter, the filing cabinet, or other machinery. Fair fidelity,

COMPACT "SOS" TRANSMITTER FOR LIFEBOATS

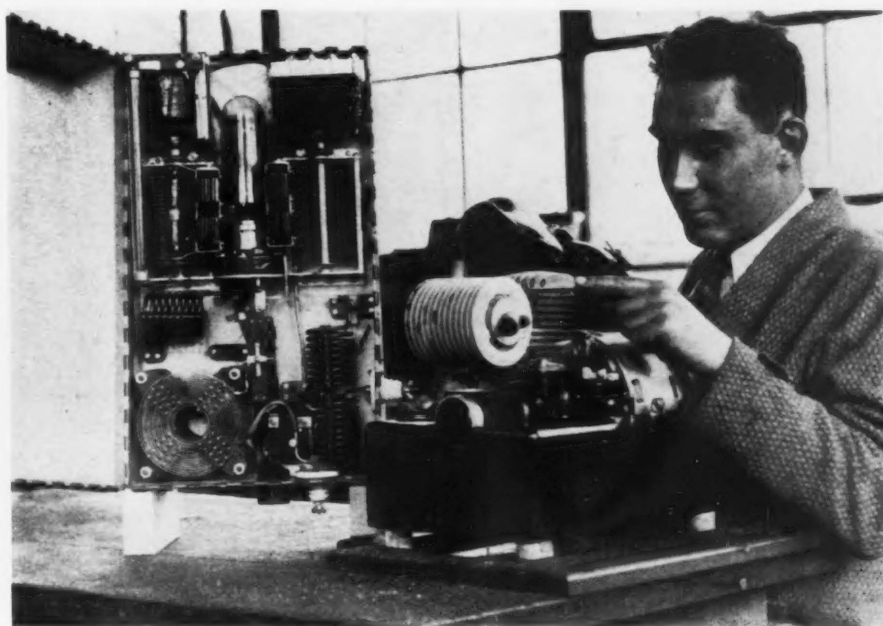

This radio power plant for lifeboats, developed by Heintz & Kaufman, San Francisco, generates 400 watts, sufficient to send short-wave distress signals 1,000 miles, and operates 5 hours on a gallon of gasoline

Radio's technical and economic progress

not much volume, only average sensitivity and selectivity are the technical requirements.

High-gain screen-grid tubes (De Forest) pentodes (Arcturus and Champion), tubes with normal characteristics but with cathode power better suited to special situations (Sylvania, Perryman and others) will be introduced. Above all the Ballantine-Snow tube (551-type) may provide the new element that may mark a major technical advance.

Home recording will progress with better microphones, and larger disks. Higher priced radios will be equipped with this apparatus, now generally considered a stunt or trick, but which may become of increasing sales value. Recording accessories to be attached to the amplifier of one's radio will make their appearance.

Communication advance

During 1930 considerable advance took place in the communication branch of electronics. Transoceanic circuits utilizing long and short waves, and ship-to-shore telephone channels were extended. Equipment for modulating a given amount of power to a greater depth was developed and put into service at broadcasting stations. At one stroke, such high modulation

equipment increases the service area of the station, and decreases interference from static and man-made sources. During the year synchronization of several stations was successfully carried out.

The year 1931 will see greater extension of high modulation. Prodding by the Federal Radio Commission will force stations to either increase their modulation or decrease their carrier. Further synchroniza-

tion will undoubtedly occur as will further extension of high power and use of vertical antennas to reduce sky wave.

Notable advance was made during the year in production testing equipment. Apparatus employing principles new to production testing was designed by RCA-Victor engineers and put to use not only in RCA-Victor plants but by RCA licensees as well.

Radio markets and products

AN unusual event took place in 1930—production fell behind sales. This was due the disastrous carryover into the early months of 1930 from the boom manufacturing year of 1929. Nearly a million of these sets were disposed of, which, subtracted from the sale of about 3,500,000 receivers, brings the year's production to 2,700,000 units. Were it not for the distress consoles disposed of by some of the larger manufacturers, it is probable that a very great proportion of this year's sales

would have been of the midget class.

The year 1931 is entered with normal inventories which indicates that production and sales are being kept well in hand—except among the over enthusiastic midget people—and that the new year may be looked forward to with some pleasant anticipation by suppliers of parts and materials. The sets and raw materials on hand are about one-half those of a year ago, a pleasant outlook indeed.

Unit sales for the year 1931 will run near the 4,000,000 mark made up largely, of course, with original and replacement sets in home plus perhaps a million units divided into farm, automobile, office and other special types. Replacements are about 25 per cent now, or since there are some 14,000,000 sets now in use the annual requirements for replacement are about 3,500,000. What the replacement factor for midgets will be, no one knows. The chances are it will be high, especially of the first year's product. In lowering cost, short-lived components have been used.

Some distress sales will take place in metropolitan centers, especially of midgets.

The farm market

The farm market may account for a quarter million receivers. These will be sold in those homes actually in rural districts (approximately 6,000,000) and those unwired homes in urban districts, about 3,000,000. During 1930 some 100,000 farms were electrified, either with private generating plants of the 32- or 110-

DE FOREST'S AUDION 25 YEARS OLD THIS MONTH



It was in January, 1906, that Dr. Lee de Forest invented the three-electrode vacuum tube, laying foundations for electronic control. Dr. de Forest is here shown as he looks today, working in his new laboratory at Los Angeles, California

—midgets, new tubes, combination sets



Production testing apparatus developed in 1931 for visual indication of faulty components

+

volt kind, or with power from city plants. This market can use electric sets. The remainder will provide an outlet for battery sets, probably using the 2-volt tubes and 2-volt battery. Estimated saturation in the so-called farm market, i.e., the unwired home market, is 32 per cent compared to 55 per cent in the wired home market.

As of January 10, fifteen prominent set manufacturers were building receivers around the Aircell battery of National Carbon Company, and the 2-volt tubes. These sets were of the seven-tube tuned r.f. type specially engineered without filament rheostats or other adjustments. Eveready ships cartons of batteries especially marked for the particular make of receiver using them. Receivers cost between \$150 and \$180, batteries included.

In less than three months to January 1, some 5,000 such receivers had been sold—about 100 per cent beyond expectation.

Automobile radios

If prices are brought below the hundred-dollar market, automobiles may require another quarter million receivers. If the price can be brought even lower, say into the midget class, an even greater sale may be expected. Traveling salesmen, tourists, vacationists and the general automobile public (there are 23,000,000 automobiles in use) may be brought to appreciate the radio as an inexpensive accessory.

General opinion is that the midget is to be a permanent part of the American market. Vision and courage on the part of the Federal Radio Commission may bring high power to other than a favored few stations with the result that daytime programs can be brought to many thousands of new listeners.

Gradual improvement of the midget with technical advances now in sight will decrease what feeling there is against the two-set idea. The additional market in offices, stores, buses, automobiles—all places where a considerable expenditure is not necessary or desirable will provide midget plants with plenty to do. This feeling that the midget will not wane in sale or popularity is shared by the majority of manufacturers, although they will state in the same breath that the midget trend is harmful to all except tube manufacturers. (Some mantle set people are making their only money on sale of tubes for original installation.) Some few manufacturers, notably those now making expensive receivers only, believe the midget is but a passing fad; many hope it is; but the majority feel

it is no fleeting but bad dream.

Some feel the midget idea may not only stay with us but may spread like a plague so that we not only have midgets but super-midgets, i.e. two and three tube sets for purely local reception where field strengths are high and stations are from 30 to 50 kc. apart. Where the profit would be in such sales, no one seems to know.

Centralized radio; additional loud speakers

Gradual or sudden entrance of radio set manufacturers into the centralized radio market may be expected. Radio sets for schools and clubs might amount to a very sizeable market, especially if receivers are engineered to supply several loud speakers instead of but one as at present.

More manufacturers will provide their receivers with jacks into which additional loud speakers could be plugged. An extra speaker for the kitchen or the nursery, or the garden might provide a very large monetary market for inexpensive, good fidelity and efficient loud speakers of the inductor or magnetic type.

+ + +

RADIO CONNECTS FIREBOATS AND HARBOR TUGS

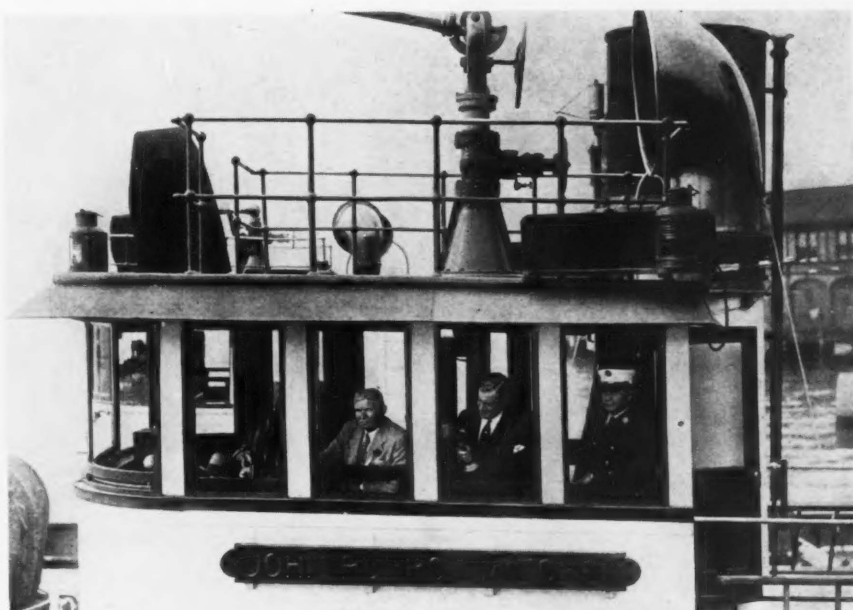

During 1930, many cities provided regular intercommunication between harbor tugs, fireboats, police vessels, etc., so that any such moving boat can be "called up" as easily as a city telephone. Picture shows New York City fire boat so equipped

Sound-picture advances—Technical

DURING the past year continued improvement in the technique of sound-picture recording was evident in the better quality of films released. In December, an announcement of unusual importance for 1931 was the new noiseless recording system of the Western Electric Company. This improvement provides a means of broadening the volume range of recording of sound-on-film, reducing by approximately 10 db. the ground-noise level present. This makes it possible to record and reproduce sounds of lower volume, enabling even whispers to be recorded, without the usual extraneous electrical, mechanical and photographic noises from masking such sounds.

The operation of this system requires an auxiliary amplifier unit, which is used to vary the spacing of the light valve ribbons of the recorder from 0.3 mil to the normal spacing of 1.0 mil. This results in the control of the unmodulated transmission of the negative sound track in such a way that the density of the positive print stops the light from the projector exciting lamp from reaching the photo-electric cell, and quietness results between dialogue or other silent

action part of the film. This development applicable to "variable density" type of recording has been in the offing since sound pictures were first introduced, but due to the poor quality of sound films during their early days, such refinements were not possible to demonstrate.

The marked improvement in sound recording will mean finer reproduction in the theater, resulting in increased patronage and revenue to the industry. This development has come at a fortunate time, for producers are trying to get more action in their pictures and less dialogue. Future development in sound pictures will result in pictures having the same freedom of action on the set as in the former case with silent pictures; sound will be used only where necessary to enhance the action desired.

A method similar to the Western Electric noiseless system for the reduction of ground noise has also been developed for the "variable area" method of recording used by the licensees of RCA-Photophone.

A small part of the output of the recording amplifier is diverted, subjected to further amplification, rectified, and then used to bias the record-

ing galvanometer in such a way that when the output of the recording amplifier is low the galvanometer is biased to such an extent that almost the whole width of the positive sound track is black. As the modulation increases the bias changes correspondingly, until the mirror of the galvanometer is back to normal position for variable-area recording.

A modification of this system has been made by RKO Radio Pictures, whereby the serrations which heretofore were on the edge of the sound track for low modulation are held to the middle of the track by the new method. The clear portion of the sound track print is matted out by the action of an auxiliary light-blocking device.

While the above two systems are applicable to "variable density" and "variable area" recording using a light valve and galvanometer respectively for the recording medium, it is expected a similar application will be made to glow-lamp recording which is also a variable density method. Such a scheme as varying the fixed intensity of the lamp corresponding to the modulation required of the recording system would vary the density of the sound track accordingly.

Markets for sound-picture equipment

Technical trends are toward the use of sound-on-film for recording and reproduction, and away from disks. It is estimated that there are approximately 2,500 to 3,000 theaters with disk equipment only, that will require additional film reproduction equipment during the coming year. In addition to the theaters now having only disk equipment, it is estimated that between 3,500 and 5,000 small theaters remain to be equipped for sound pictures. During 1931 it is expected that the majority of these remaining theaters will have sound equipment installed. This market is open to a number of companies who have good equipment. Simplicity of installation and minimum finance charges are necessary to sell the remaining theaters.

The replacement market for sound equipment for 1931, while not large in numbers still will represent a sizable sum in dollars. Such replacement will be made where earlier and inferior sound equipment does not have the quality and reliability of

SOUND PICTURES ENTER COMMERCIAL SPONSORSHIP

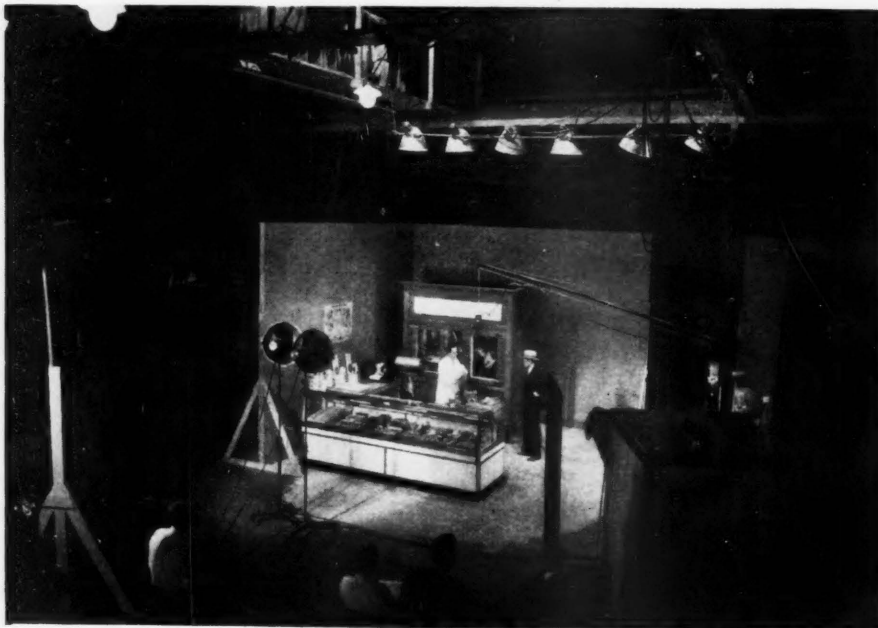

Sound movies are now being made by manufacturers to educate the public, sell goods, and instruct sales people. The illustration shows a commercial film in production at the Jam Handy Studios, Detroit, Mich.

improvements in 1931—New uses

present reproducing apparatus. No further important reductions in prices of sound apparatus is expected during the year. The larger companies have stated their present prices are about the bottom for good equipment. It is expected that future installations will be better standardized to reduce expense and minimize chances of failure of sound, due to wiring defects. The number of models will probably be reduced and equipment will be so standardized that theaters of all sizes can make use of standard units.

Sound equipment for industrial and educational uses

The market for sound equipment in the industrial, educational and religious fields depends largely upon the development of a library of films suitable for these groups. Up to the present, at least, the lack of such libraries has been the bottle neck, preventing further sales and distribution of such equipment. Definite steps are now being taken by one of the leading companies to set up a complete production organization for the handling of educational and similar subjects. Potentially, there is a great market for portable and semi-portable sound equipment in this field. When it is realized that there are 50,000 elementary schools and 30,000 high schools in this country, some idea of the tremendous equipment business which lies ahead in this field, may be had. The position already obtained by sound equipment for this field will be better consolidated during the coming year and a firmer foothold gained in the wider possibilities of this great market.

Sound pictures for advertising purposes while already on the market, will have an opportunity to demonstrate their value during the coming year. Paramount and Warner Bros., as well as RKO, have already announced plans for releasing such pictures before their theater audiences. Such pictures, unless they have unusual entertainment value, will be restricted to certain theater chain groups for distribution. The ultimate reaction of the public to such advertising schemes has not yet been definitely determined. Other leading producers have announced that they will not jeopardize the attendance at their theaters for the relatively small income to be derived from such pic-

tures. Distribution of special advertising pictures through non-theatrical local agencies seems hopelessly limited. The distributing of such sponsored pictures on 16 mm. film for home movie use may have a good outlet, provided home equipment receives wide adoption. National advertisers are spending large sums over the radio chains for programs, that would have a tremendous pulling value if sight could be combined with the description. This might open up the possibility of film libraries placed at strategic points for distributing sponsored pictures to the home market.

Wide-film developments

In the past year, many optimistic statements were made concerning the adoption of wide film by the industry in the immediate future. Pictures made on wide film, and shown in various parts of the country, have not made the box office records expected. This is perhaps due to the fact that not only the story material, but the technique of producing wide-film pictures, must be revised in order to

incite public interest. The scenic views presented with the wide film, and also mob scenes, have made the biggest hits, because the standard screen is too small to include such scenes to the best advantage.

The industry has not yet agreed on a standard width for such film, although the Standards Committee of the Society of Motion Picture Engineers has reached an agreement on a picture shape of 1.8-to-1 as the ratio of width to height. The final overall width of such film has, however, not yet been agreed upon but a compromise is expected to be reached on a film around 50 mm. wide.

Paramount presented on December 5, in its New York studios, its latest development of wide film equipment, which has been made for 65 mm. film though adaptable to a narrower width. (See December issue of *Electronics*, page 410 for description.) No further definite progress can be expected until the industry adopts a standard width. This is one of the outstanding problems that should be settled at an early date, in order that future

HOME TALKIE BECOMES SALESMAN'S TOOL

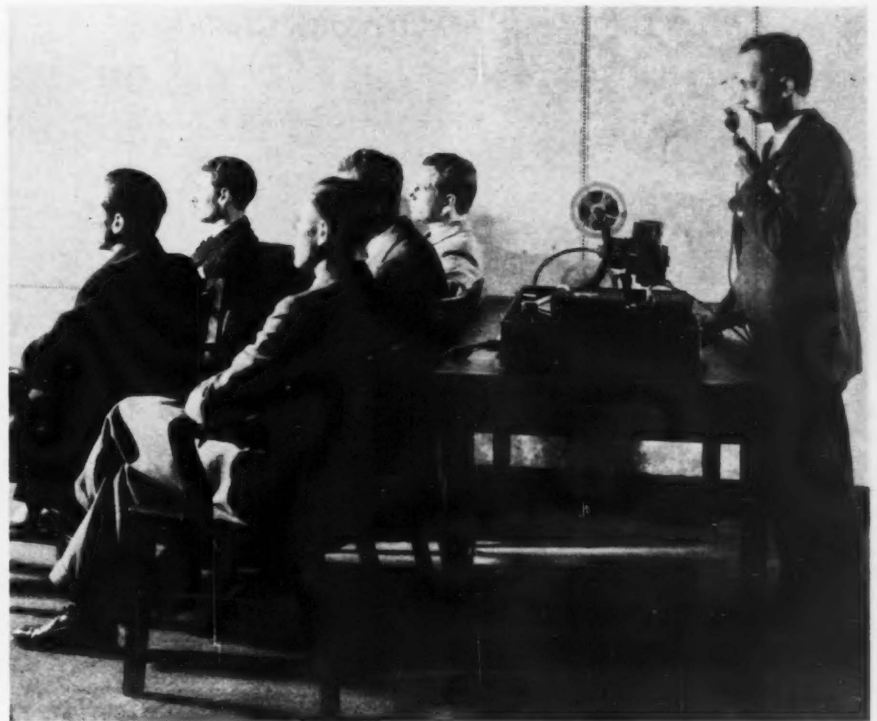

Salesmen and lecturers are now making use of home talkie outfits to demonstrate to audiences and classes. The microphone enables speaker to interpolate his own remarks. Equipment designed by Bell & Howell Company

Sound equipment markets—theater,

developments in wide film may proceed in an orderly manner. Some of the leading authorities agree that the introduction of wide film equipment will be gradual but that definite steps will be taken to equip de luxe theaters during the coming year.

New photo-electric cell

An important development in sound projection equipment is the introduction of a more efficient type of photo-electric cell in the near future which will tend to reduce the background noise of the projection system by approximately 10 db. This cell, it is expected, will greatly contribute toward the elimination of film background noise resulting in marked improvements in sound reproduction. Improvements due to better mechanical motion, particularly in the reproducing system are looked for during the coming year.

An increase in the use of directional microphones is expected and wider application of this equipment may lead to unlooked-for improvements in pick-up technique and long range recording.

An increasing number of foreign

language versions of sound pictures are expected to be made in the Hollywood and Eastern studios during 1931. Producers, in order to retain present foreign markets, are compelled to produce as many as possible such pictures, as non-English speaking countries require talkies in their native language.

Producers in foreign countries including Germany, France and England will have produced approximately 300 sound pictures during the past year and an additional 175 multilingual pictures will have been produced in this country. Production plans for the coming year are equally ambitious, so there will be a plentiful supply of sound pictures for the foreign market.

The export market for sound equipment will receive an increased impetus during the coming year. Only those companies having an aggressive export policy and personnel can expect to make the most of this opportunity. Exact statistical data on the total sound installations abroad at the close of the year are not available but the following table may be taken as approximate:

FOREIGN THEATERS

	Number of Theaters	Theaters Wired End of 1930
Europe.....	27,000	6,500
Far East.....	4,000	1,000
Latin America...	4,000	550
Canada.....	1,100	600
Africa.....	750	75
Near East.....	50	20
Total.....	36,900	8,745

While the total number of theaters wired may seem relatively small as compared to the total it should be noted that those theaters equipped, represent the largest and best theaters in the respective countries. The remaining theaters have a seating capacity generally below 1,000 and the majority under 500, so that equipment for the remaining market will have to be reasonably priced to have an outlet. Competition with sound equipped theaters and lack of silent films will cause many thousands of these theaters not yet equipped to purchase sound equipment during the coming year.

Equipment for "little theaters"

A recent tie-up reported between RKO and Trans Lux Daylight Picture Screen for the establishment of little theaters to be known as Trans Lux Theaters may be the beginning of a revolutionary movement in the theater business. This plan calls for the use of rear screen projection which in itself is a novelty.

Three of these smaller theaters are expected to open in New York City after the first of the year and future plans call for extending the chain throughout the country. Theaters will be designed to seat not over 500 with an admission price of 25 cents. Shows presented will consist of a feature picture lasting about 60 minutes and news reel 30 minutes. The experiment will be first tried in the Grand Central zone, New York. It is claimed that such a chain of little theaters will represent a smaller investment and overhead than present theater chains.

Sound equipment for such units will be portable or semi-portable installations at first—and should such a movement gain headway it will open up a new market for compact and easily installed sound units.

Since the September 1930 issue of *Electronics*, which discussed the tech-

NEWSREEL SOUND-PICTURE CAMERA

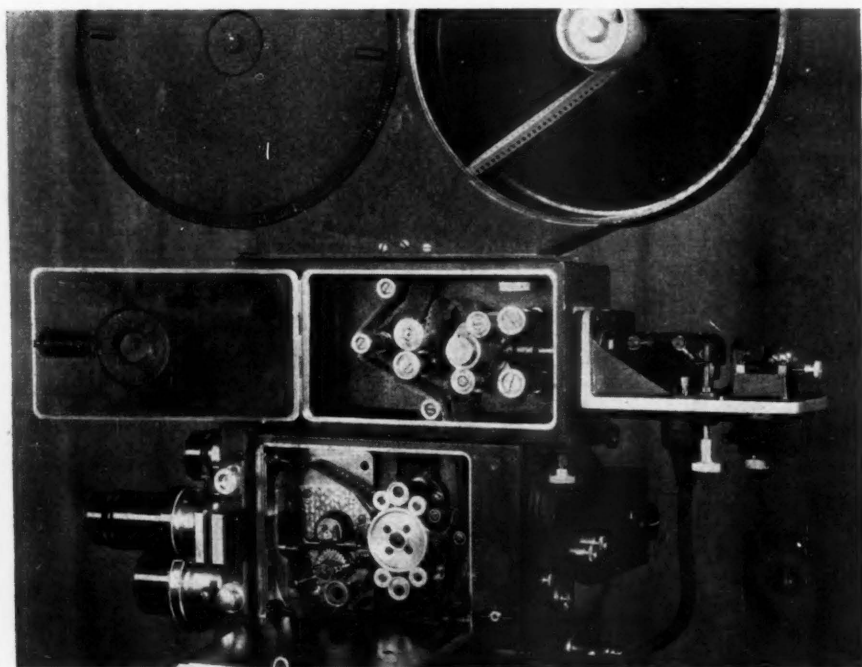

View of the latest type of "newsreel" sound camera developed by the RCA-Photophone organization. The recording oscillograph is attached directly to the upper section of the camera head

industrial, educational and home



This home talkie cabinet includes turntable and 9.5-mm. projector unit as designed by Pathé

nical design of 16 mm. equipment then available, no unusual developments have occurred in apparatus for the home market. Pathé Films, Inc., has recently announced a new sound projection unit designed for 9.5 mm. film with disk turntable, and to retail for \$199. The picture area of such film is almost identical to the standard 16 mm. film. Only one sprocket hole is provided for this film, it being placed in the center of the film between frames. The disk turntable is driven by a small motor of special design, which is coupled to the projection unit by a rigid shaft. The projector unit is built in France, all other equipment being of domestic make. A double filament projection lamp is provided, which, together with a unique lens system, furnishes excellent light intensity on the screen. This company has now available over 100 sound picture subjects. The estimated cost of 9.5 mm. film is given as approximately one-third less than for 16 mm. Whether this saving in film cost will warrant any change in the generally accepted 16 mm. standard width for home use, is problematical. All other equipment so far announced for this market uses 16 mm. film with disk reproduction for the sound. In view of the great numbers of 16 mm. cameras that are also being sold, the question of introducing a new width film for this market at this time unnecessarily complicates promotion in this field.

Other 16 mm. equipment on the market

The Bell & Howell Company has recently introduced two interesting models for the home and industrial sound movie field. One of these models is a portable unit, consisting of an amplifier and turntable unit with a flexible shaft provided for coupling the turntable to a standard 16 mm. projector. Another very elaborate model, combining a phonograph, radio and projector in one cabinet, has been brought out by this company.

A home sound movie equipment of unique design has also been announced by the Victor Animatograph Corporation. This unit comprises a Victor projector unit, with the turntable mounted in a vertical position. The pick-up is counterbalanced to give correct tension on the disk, and to prevent slipping. A feature claimed for this unit is the safety control to prevent film breakage and its extreme compactness when disassembled. The projector and turntable unit is designed to retail for \$335 with two models of amplifier

speakers, a smaller model listed at \$85 and a larger model at \$125.00.

Other leading manufacturers of silent home movie equipment are pushing development plans for sound equipment to be introduced in 1931. Equipment for this field ranging from a simple turntable attachment retailing under \$50, to the more elaborate units comprising a radio, projector, turntable and screen, and selling as high as \$600, may be expected. The market for home sound movies is not sufficiently established to determine the type of equipment most suitable for general public demand. It is felt, however, that a complete sound projector and turntable, mounted in one cabinet, and selling under \$200, will be the equipment having the best market. No great demand is seen for portable units in the home which require a complete set-up each time a show is to be given. Manufacturers should consider this point carefully in building equipment for the home market.

It is estimated that upwards of 30,000 silent projector units will be
(Continued on page 461)

WIDE-FILM SOUND PICTURE CAMERA

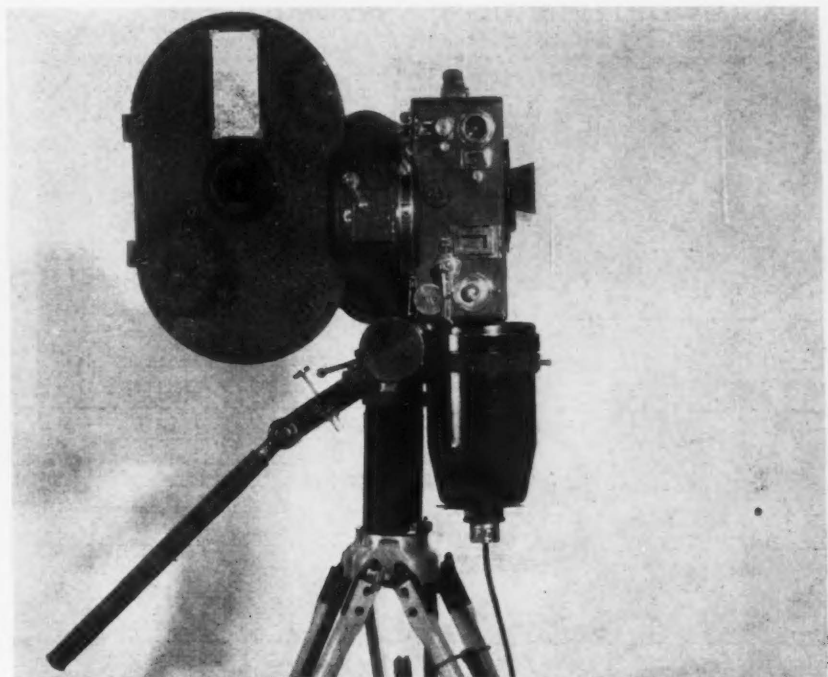

First photograph published of the new 65 mm. sound picture camera developed by Paramount. Entire rear half of camera is detachable, including gate and intermittent. It is equipped with automatic focusing device

Electron tubes in industry—Future

THE past five years have been momentous ones in the history of the tiny electron. But the five years ahead seem destined to bring even more revolutionizing influences into everyday life.

Since 1925 the electron tube, through radio broadcasting, has reconstructed American home life and home entertainment; it has brought us "sound movies" with doubled attendance and box-office receipts; it has linked together by telephony the continents of the antipodes; it has created bloodless surgery and healing artificial fevers; it has effected new control of power, motors, lights and heat; it has wrought miracles of might and of delicacy in every department of science and industry.

Electron-tube lighting

And the next five years undoubtedly will witness even more sweeping advances of this electron host. Perhaps one of the most striking of these changes will be the development of new electronic light sources to replace our present electrical illuminants. Already electronic or gaseous signs are replacing the older incandescent-lamp displays, and saving two-thirds of the

electricity consumed by the former signs. And now these same neon tubes and helium envelopes are being employed to light interiors, art galleries, homes and offices. Meanwhile in Europe and America are being developed new hot-cathode neon lamps which may make possible new efficiencies of light three to five times as economical as any we have today.

With the photo-electric cell or "electric eye" (which is sensitive to light and darkness, and which, through relays, can thus operate switches), our factories, buildings, schools and homes will eventually all be lighted automatically at the approach of darkness. Our heating systems have thermostats that turn on the steam when the room gets chilly; why not "light-o-stats" that will turn on the lights when it gets dark?

The powers of radio broadcast stations will progressively increase, until even 500 kw. or 1,000 kw. (10 to 20 times the power of the present largest station), will seem commonplace. Meanwhile our telephone and electric light wires will bring us broadcast music and entertainment, supplementing the air channels and eliminating

the fading, static and interference that seem to be inherent in ether broadcasting. Television will be an accomplished thing, but will come perhaps chiefly over wires as well as by radio. Probably even seeing across the Atlantic by cable will not be an impossibility.

With our new electronic aids we shall be sounding the depth of the universe with new types of telescopes—simple, inexpensive, and much more powerful than the crude and massive monsters of modern observatories (which have had no fundamental technical improvement since Galileo). In the direction of the minute and infinitesimal, also, we shall undoubtedly extend our present scale of electronic measurements, which today can caliper a faint star and detect its transmitted heat, or can indicate electric currents down to the one-quintillionth part of an ampere!

Elaborate new musical instruments will employ either photo-cell sound tracks, or electronic-tube oscillators, combining frequencies to produce harmonics, timbres and qualities sweeter than any product of our present-day instruments, which depend upon mere accidental vibrations of strings, hammers, cat gut, horse-hair, brass tubes and other devices.

X-RAY DETERMINES SEX BEFORE BIRTH

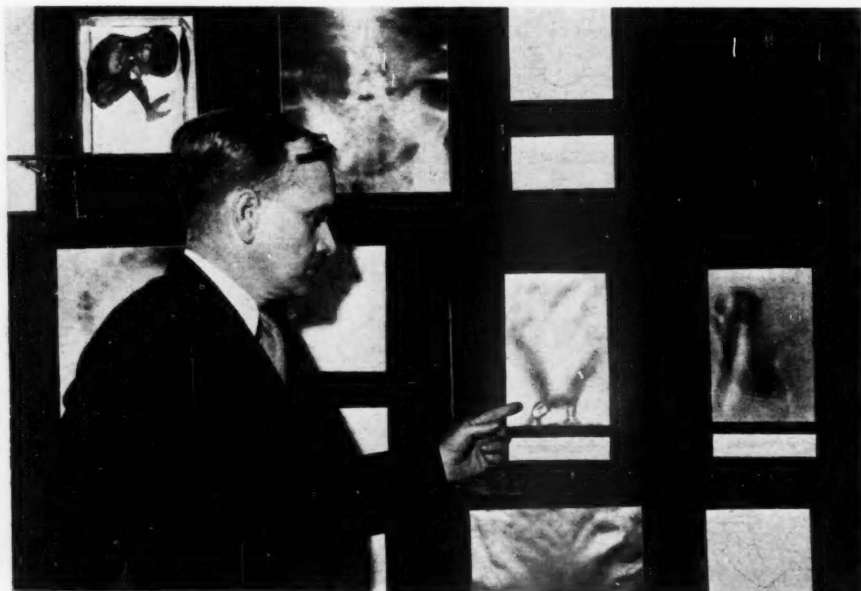

Dr. T. O. Menees of Grand Rapids, Mich., demonstrating before American Association for Advancement of Science at Cleveland, Dec. 30, 1930, his strontium technique for determining sex of unborn child, three months before birth

Electrical power transmission

Undoubtedly in the power field we shall be transmitting high-tension direct-current instead of alternating current, and thus increasing line efficiencies and capacities three to six-fold. Tubes will convert from a.c. to d.c. for transmission and thence to any desired frequency best suited to the load. Tubes will replace high-tension switches, circuit breakers and lightning arrestors.

Within twice five years we may even be transmitting our energy over high-frequency radio beams in the ether, entirely without wires. Who can say no? Airplanes may be taking their power supply from such beams of radiated energy, which will also guide them. This may sound the height of absurdity in January, 1931, and would not be seriously mentioned here, were it not for the fact recently two of the sanest and most fruitful engineers in the country, each with world miracles to his credit, independently and confidently propose the

markets for wide applications

early possibility of this very thing!

The year 1930 has witnessed some ingenious industrial uses of vacuum tubes and electronic devices.

At one of the large steel companies, a battery of soaking-pit furnaces have their covers controlled by photo-cell relays. When the traveling-crane operator desires to open one of the furnaces, he simply projects a beam of light on the corresponding photo-cell, and the pit opens. This method eliminates the complicated trolley and wire connections otherwise needed, to operate the covers from the traveling crane.

Photo-cells are being used to control winding reels, over a speed control of 20 to 1. Formerly a man was needed to vary the speed, and maintain a free loop of the product. Now the photo-cell does the job. In a wire mill, a three-electrode mercury tube has been similarly used to maintain uniform tension on the reels.

Like flour, cement now comes in decorated paper sacks. As the roll of printed paper rushes 800 feet a minute over the bag machine there is a big chance that the cutting-off shears may blindly cut at the wrong spot. But an electric eye has now gone on guard; it watches the designs rushing past and gives the word to the shears at exactly the right moment. The same service is being rendered the transparent cellophane envelopes of cigars.

For operating sand sifters in foundries, vacuum tubes now afford actuating frequencies of 30 cycles per second, giving speeds of operation not heretofore possible. Such shakers have a large number of future applications in industry.

Foods, therapeutics

Electron tubes will effect revolutionary changes in our food supplies. Tubes form the heart of our new surgical and therapeutic aids. Tubes will be major factors in eliminating certain diseases from the human family. We know already that tubes seem to affect hereditary changes and the creation of new species, and possibly they may even predetermine sex.

In fact, the sweeping changes which the vacuum tube will effect upon the life of the human race within the decades ahead may very likely cause this century and period to be known as "The Electronic Age."

Sound equipment

[Continued from page 459]

sold in 1931, and over 10,000 home sound equipments. There are several factors that will have a definite bearing on this market during the coming year: the aggressiveness with which manufacturers go after the market, general business conditions, and the establishment of adequate film libraries.

Establishment of film libraries

The whole development of home movies will depend upon adequate libraries being available at convenient points in the principal cities. The rental of such sound film must be reasonable to compete with the entertainment offered by community theaters. The availability of such libraries is nearing a solution with the recent licensing of Universal Films, Inc., by Electrical Research Products, the subsidiary of Western Electric Company, for producing 16 mm. sound films for the home. Also, the licensing of Pathé Films by RCA-Photophone for the making of home movies has made immediately available over 200 subjects for this market from these two companies. Other

large producers are taking definite steps to enter the home movie field and signs of real activity are prophesied after the first of the year.

Public address systems

There will be an increased demand for portable public address systems during 1931. Equipment designed to sell under \$1,000 and which can be sold to radio dealers and other electrical outlets for rental purposes at banquets, conventions and similar gatherings should have a good market. With more high and public schools adopting large group setting up exercises, an opportunity for selling a portable or semi-portable public address equipment for the use of the physical culture instructors should be possible.

It is estimated that approximately 2,000 complete public address equipments varying from a single amplifier and speaker unit up to three and four panel amplifier installations will be sold during the year. Further simplification is needed in some of the permanent equipments to reduce installation costs. Portable equipment should have an even greater market depending upon the aggressiveness of the sales force.



THYRATRONS, GRID-GLOWS, HAVE BIG 1931 JOBS

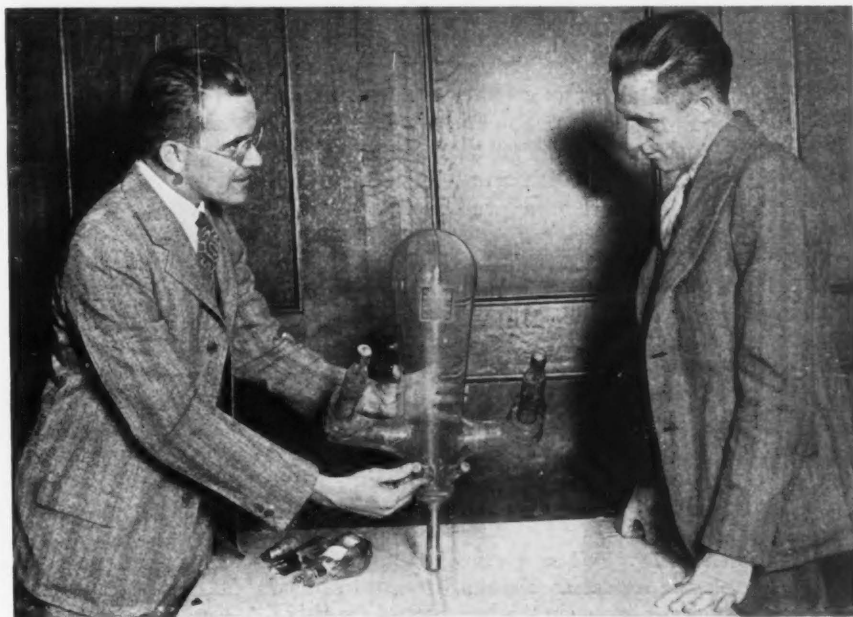

The family of mercury-vapor three-element electronic tubes variously known as "grid-glow" tubes, "thyatrons," etc., will find many new important industrial applications during 1931. The tube shown breaks a welding current of 75 kw. 500 times per minute

Einstein and the electron

By DR. H. H. SHELDON

President New York Electrical Society,
Prof. of Physics, New York University

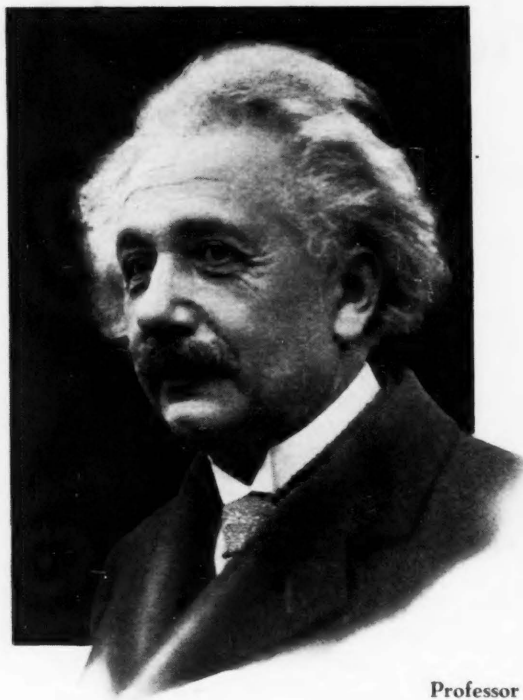

Professor Einstein

FEW specialists in the field of electronics, even though well acquainted with the development of our knowledge of the electron, think of Einstein as one of the greatest contributors to this branch of science. Yet if Einstein's reputation were to rest wholly and entirely on his work in this field he would bear a great name. It is only because his work in relativity has eclipsed his work in other fields that we forget about his great contributions to electronic science.

No one will question the place that the photoelectric cell will occupy in the future. It seems destined to become man's greatest aid in automatic control. Our fundamental equation which expresses the relation between the wave-length of light striking the cell and the energy of emission of electrons was developed by Einstein. Not only does this famous equation permeate all the literature concerning photoelectric cells but it was the forerunner of all of our exact experimental knowledge of photoelectric currents. The equation was derived by Einstein without knowledge of the manner in which the action took place. With true Einstein brilliance he developed this equation as a prediction. It was found to fit the facts exactly.

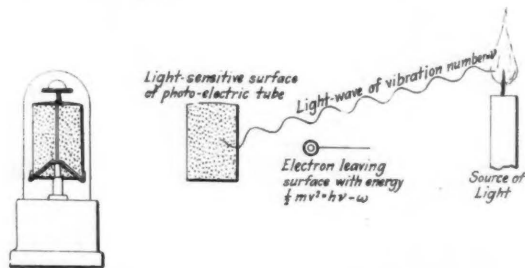

Photoelectricity. When a ray of light strikes a photoelectric surface an electron is emitted with a velocity depending upon the frequency of the light. Einstein's statement of the fact that this electron has a kinetic energy equal to the energy imparted by the light ray minus the energy required to release the electron ($\frac{1}{2}mv^2 = h\nu - \omega$) is the starting point of all photoelectric theory

But greater than this contribution is a second equation which tells us that mass and radiation are interchangeable. It is simple in form like most of Einstein's final results. It tells us that when mass is changed into energy then the energy produced is equal to mc^2 , where m is the mass which has disappeared and c is the velocity of light. The large value of c shows that an enormous amount of energy is produced from an insignificant amount of mass.

This equation has been fruitful in explaining many phenomena. It has been particularly useful in the field

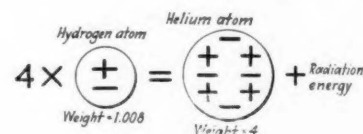

Equivalence of mass and energy. When four hydrogen atoms combine to form one helium atom the atomic weight of the resulting helium is not four times the atomic weight of hydrogen (4×1.008) but is 4.000. The 0.008 of each hydrogen atom is radiated as energy

of astronomy where it has been employed to explain the long life of the sun. The sun is no longer thought to supply us heat merely as a cooling body but is now believed to derive its heat by the conversion of its mass into radiation in its intensely hot interior. The same equation has been used to explain the existence of cosmic radiation, which consists of waves so short as to be well under the lengths of the gamma rays produced by radio-active substances.

Either of these two great contributions would have been sufficient to have placed Einstein's name among those of the world's greatest scientists. Yet the field of electronics is not that of his major interest. These are but by-products. In his work in his major field there is promise that as another by-product he will solve, or at least give to others the tools to solve, that problem on which the great majority of physicists of today are puzzling; the problem of the structure of the atom.

No one has ever yet been able to explain the peculiar mass-electrical relations which exist in the electron. Many years ago the brilliant experiments of Kauffman showed that the mass of an electron changed with its velocity, increasing in such a way with speed that at the velocity of light it should have an infinite mass. For some time physicists tried to distinguish between mass in the ordinary sense and this new mass which increased with velocity and which came to be called electromagnetic mass. Some were bold enough to suggest that all mass might be electromagnetic. But no proof as to the similarity of these two kinds of mass has been forthcoming, nor yet is there any proof that they are different. Here again Einstein plays an important rôle for were it not for the fact that length also changes with velocity, as his theory of relativity tells us, we could not apply our ordinary laws of mechanics to these rapidly moving electrons. Our relations between mass, length and time would all be changed. But as it turns out mass and length change in such a way that our equations still hold.

Not until we know more of the relation between

Electron at zero velocity, has mass equal to $\frac{1}{1837}$ mass of hydrogen atom.

Electron at velocity of light,* has mass of infinity.

* (186,000 miles per second, or 3×10^{10} cm/sec.)

Relativity. Einstein states that in the case of an electron, an increase in mass is experienced as its velocity is increased. If the electron could be speeded up to the velocity of light its mass would become infinite

gravitation and electricity is it likely that we will be able to bring any order out of this chaos. This additional knowledge Einstein is rapidly giving us. A year ago, in his famous fourth paper before the Prussian Academy of Science, he presented equations giving relations between electricity and gravitation. Thus two more physical phenomena were united. The advance of science depends upon such tie-ups. Our knowledge of the relation between heat and energy was absolutely essential before we could hope to have steam engines designed on efficient lines. We need to know something of the relation between chemical energy and electricity before we can design an electric battery. We may utilize the force of gravitation to produce electricity by means of the water-fall but we can do so only in a crude way. We have no knowledge of any way in which gravity can be controlled. This may be one of the many reasons why we cannot fathom the atom. Gravity conditions inside the atom, the gravitational attraction of one part of the atom for another, may not be anything like what we now think it is.

Linking gravitation with electromagnetism

But in his fifth paper, presented but a short time ago, Einstein gives us the very tools we need. He has taken his general equations which give the relation between gravitation and electricity and has applied them to the case of a charged isolated sphere and to the case of

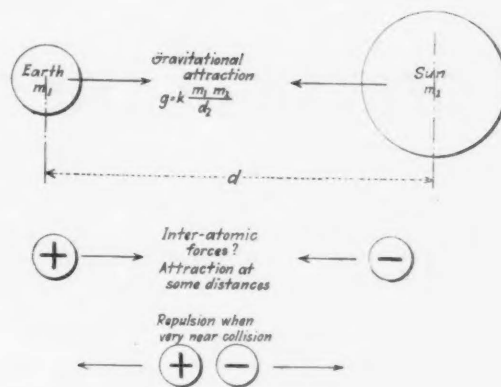

Gravitation and electricity. Einstein has given hopes of eventually understanding the peculiar forces which hold atoms together, by his equations connecting gravitation and electricity

a number of charged points in space. Both of these cases are at once useful. The first case, the isolated charged sphere, is analogous to an electron in space free from any atom. The second case is analogous to the atom itself if we regard it as made up of a number of charged particles which are of the nature of points when compared to their distances apart. The equations which he derives in solving these two problems are extremely simple in form. The relation between the gravitational and the electrical terms is direct, these being the only two variables.

It is to be expected that these equations will soon be put to a test in the formulation of a theory of atomic structure. Since his present solution holds for an atom made up of discrete particles it will obviously not fit in with the new "wave-theory" of the atom which looks upon the electrons somewhat as space charges of an undulatory character. Undoubtedly his general equations could be solved for a case of this kind as well as for the other but the solution would obviously be much more difficult.

Reconciling atom-theory with electronic facts

Should a theory of atomic structure based upon his present solution be found to give a close approximation to the facts of electronics it will be a great day for students of this subject as well as for Einstein. Unquestionably our present rapid advance in the field of electronics has been due to the ease with which one could picture what was going on in our vacuum tubes and so on when the electrons were thought of as discrete particles each carrying a charge. There is, of course, too much experimental evidence that there is a wave motion which goes along with an electron ever to neglect this idea entirely. But if we could think of it as a secondary affair, just as we think of a wave which accompanies a boat, we should be much happier.

If all the potentialities of Einstein's recent work are realized he will become, almost without effort in that direction, one of the greatest contributors to the field of electronics that the world has known. That the full possibilities as we see them now may be realized is by no means impossible. In his previous work the full realization of its value came only some years after announcement. Specialists in electronics as well as mathematical physicists will do well to watch Einstein.

A practical method of "toe" recording

for light valve
sound equipment

By GEORGE LEWIN

Recording Engineer, Paramount Publix Corporation

TOE recording derives its name from the fact that in this system of film recording, the unmodulated exposure of the negative is held down to a point on the toe of the H & D curve of the film, rather than upon the straight line portion. This is illustrated by Fig. 1, which shows a typical H & D curve for positive stock, such as is commonly used in recording by the light valve method. Ordinarily the recording lamp current is adjusted so that the unmodulated exposure is held at the point (a). This allows practically full modulation of the light valve, without exceeding the straight line portion of the curve, and is in accord with the generally accepted theory of film recording by the variable density method, whereby, by proper choice of negative exposure, printer point, and overall gamma, we obtain a linear relationship between negative exposure and print transmission, which is essential to high quality reproduction.

In toe recording, however, the exposure is reduced to a small fraction of the value ordinarily used, and is indicated by the point (b) in Fig. 1. The moment exposure drops below the straight line portion of the H & D curve, mathematical theory is no longer applicable, as there is no general equation for the toe of the curve. However, if we deal with exposure and transmission of the film, rather than with log exposure and density, the constants for toe recording can be determined by graphical methods quite readily. This was the method used in developing the system to be described in this article. No originality is claimed for the principle of toe recording, as it is realized that this principle has been used before, but it is felt that the system to be described has been worked out in a rather novel manner and moreover presents some interesting advantages which are not realized in other systems of film recording.

Toe recording has been used in the past principally of necessity, due to difficulty in obtaining sufficient exposure

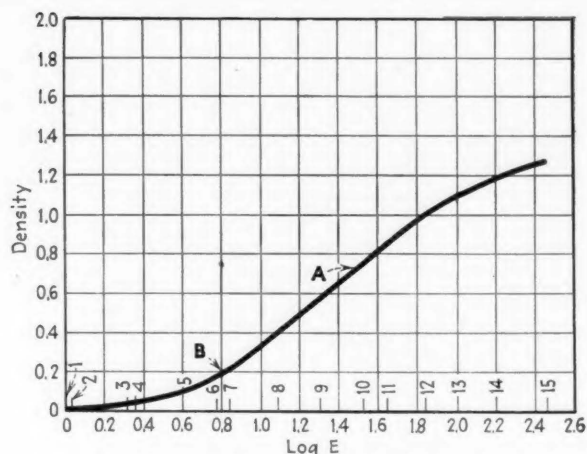

Fig. 1—Typical Hurter and Driffield curve for positive stock film as commonly used in sound recording

to record in the conventional manner. This has been the case chiefly when recording with various forms of glow lamps, which are relatively feeble in light value. When using a light valve, in conjunction with an incandescent lamp, no difficulty is experienced in obtaining sufficient exposure for straight line recording, and toe recording has been studied chiefly for the purpose of realizing advantages other than the mere saving of lamp current. Among the advantages which this system of toe recording presents, the following are of principal interest:

1. Negative and print are both developed in the positive bath at the same gamma eliminating the use of a negative sound bath.
2. The negative can be played back, with quality equal or better than that of a print.
3. Saving in time can be effected by using the negative for synchronous playbacks for subsequent photography, or for scoring from sound tracks.
4. Toe recording negatives are ideal for frequency films, due to steadiness of readings and improved frequency response.
5. Toe recording negatives and prints give more output level than regular process print, for the same recording level.
6. A saving of approximately 30 per cent in lamp current is effected.

No special treatment required

In determining the proper lamp current for this system, all measurements were made directly in terms of light valve exposure and photoelectric cell transmissions, so as to avoid errors due to failure of reciprocity. The film was developed in the regular positive picture bath, at the regular gamma, so that no special treatment or timing would be necessary. In other words, the system was adapted to meet existing conditions, rather than to create new ones.

The first step was to record a series of exposures corresponding to different light valve openings, during a complete cycle, thus furnishing the data for a series of curves showing the relation between light valve exposure and negative transmission, for various lamp currents. In order to do this it was first necessary to devise a means of quickly and accurately varying the spacing of the light valve in known amounts. This was accomplished by passing direct current through the valve and measuring, by means of the photoelectric cell in the recording machine, the valve spacing corresponding to known values of current. This furnished the data for the curve shown in Fig. 2, which may be termed a light valve hysteresis loop, due to its similarity to a magnetic hysteresis loop. The hysteresis in a light valve, incidentally, is probably

due to the friction between the light valve ribbon and the bridges upon which it rests.

From the data furnished in Fig. 2, it is a simple matter to determine the spacing of the light valve corresponding to various values of current. To facilitate the process of varying the current rapidly and accurately while the exposure test was being made, a potentiometer box was made up, by means of which the currents could be set beforehand, and the changes then made rapidly by simply moving a dial over a set of switch points.

After adjusting all potentiometers, and going through a complete cycle several times to make sure the various valve openings were correct, a test was run off at several different lamp currents, all on the same roll of film. The film was then developed in the positive picture bath at the normal time of development. The transmission of the sound track corresponding to each value of light valve opening was then measured by running the film slowly through a recording machine and measuring the output of the PEC monitoring amplifier, while the light valve was modulated with a constant tone.

The loss in level due to a transmission T , may be expressed by the equation

$$DB \text{ loss} = 20 \log 1/T$$

from which the transmission of each sound track area may be calculated. From the data so obtained, the curves in Fig. 3 were plotted. By inspection of these curves it is apparent that there is quite a range of exposure over which the transmission varies in practically a straight line. It is only necessary to select a value of lamp current which will allow the light valve to modulate 100 per cent, without exceeding the straight portion of the curve,

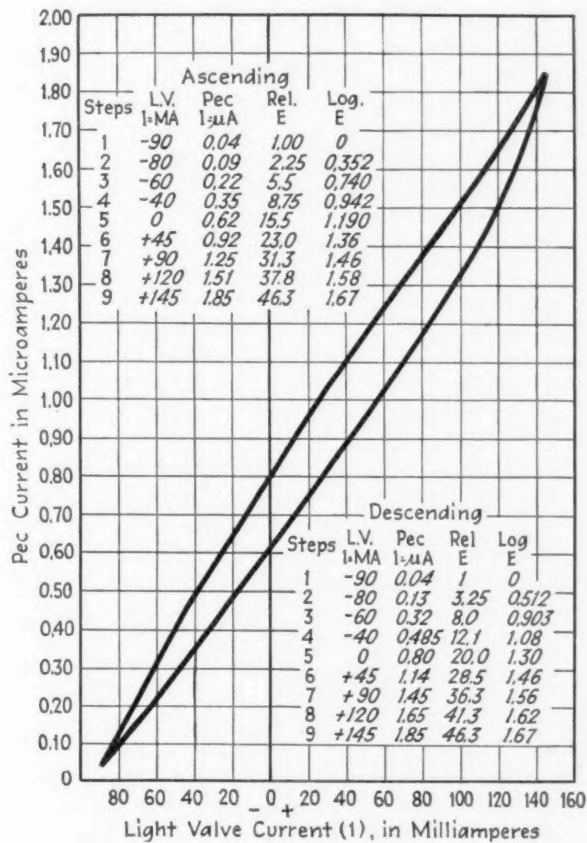

Fig. 2—Light valve hysteresis loop obtained by passing direct current through the valve and measuring by means of photoelectric cell ribbon spacing for known value of current

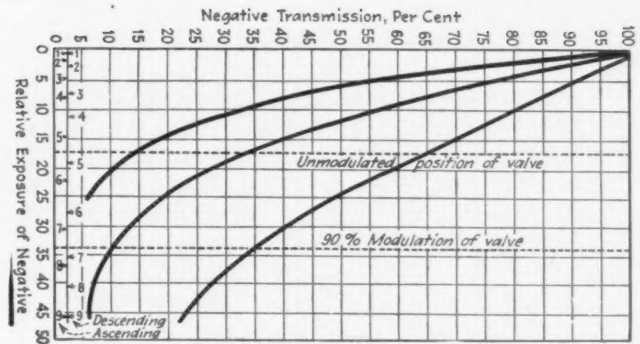

Fig. 3—Relative exposure of negative vs. negative transmission measured by volume indicator method

and this should give us good recording quality. The desired lamp current should lie somewhere between 12 and 13 amperes, and by assuming a value at about 12½ amperes, it is seen that the negative will yield an unmodulated transmission of 50 per cent and a straight line relationship for at least 90 per cent modulation. This has been borne out by actual recording tests at this value of lamp current. Of course, the relation between negative exposure and negative transmission is inverse, and not direct, but this has no bearing on the quality of the sound.

In determining the printer point to use in making a print of a toe recorded negative, it was only necessary to expose a film through a negative of 50 per cent transmission, at various printer points, develop this in the positive picture bath at normal time, and select the one which yielded a print transmission of 50 per cent.

In order to make a more comprehensive study of the relation between negative exposure and print transmission, however, a print was made of the entire test which had been used for determining the negative exposure, as described above, and this print was measured in the same manner as was the negative. The results of this test are plotted in Fig. 4. While the printer point used on this particular test was not exactly correct, it is close enough to illustrate the principle involved. It will be noted that the relation between negative exposure and print transmission becomes direct, just as it does in the conventional process of recording, and that it is a straight line for about 90 per cent modulation of the light valve. The only radical difference between a regular process print, and one made by toe recording, is that, whereas the regular print should have about 25 per cent transmission or less, for good quality, the toe recording print yields perfectly good quality at 50 per cent transmission, and therefore gives a higher output level for the same recording level. This will be discussed more fully later.

Advantages of toe recording

Regarding the advantages of toe recording over the conventional process, a few words of discussion might not be amiss. The first advantage mentioned above is the elimination of the necessity for a negative sound bath. This is a decided advantage, as it means that only one bath will suffice for both negative and print, as well as picture prints. All film is developed to the same gamma, so that no re-timing is ever necessary. Moreover, it should be noted that slight variations in gamma will have less effect on toe recording than on the ordinary process, since the toe of the H & D curve changes much less than the straight line portion for a given change in gamma. Furthermore, the overall gamma has very little

effect on toe recording, since all we are interested in is getting 50 per cent transmission in both negative and print.

The second feature—that the negative can be played back with excellent quality—is the chief reason why we have made extensive use of toe recording. Many sequences in sound pictures are prescored for various reasons. That is, the sound is recorded first and the action photographed later in synchronism with the playback of the sound track. In such instances it is usually an advantage to have the film available for playback as quickly as possible. Soft wax playbacks have been resorted to in such cases, but without great success, as it is difficult to make the playback needle follow the original groove from the start mark, especially after the wax has been played back a number of times. Also, a wax recording will often cut over, and be useless for playback while the film is perfectly good. Again only a certain part of the take might be desired for playback, and this could be cut out of a film and given a new start mark, which could not be done with a wax record. In such instances as these, we have resorted to toe recording, as the negative can be developed and be ready for playback

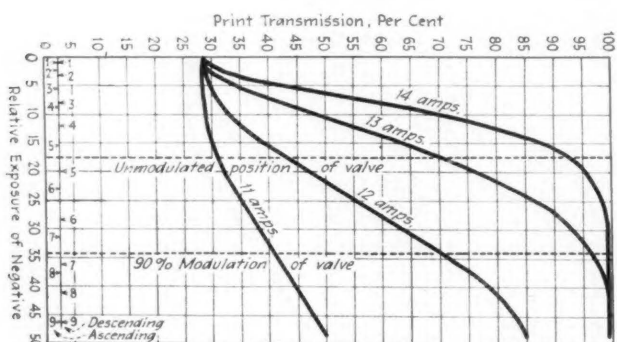

Fig. 4—Relative exposure of negative vs. print transmission measured by photoelectric current

within one hour, whereas a regular recording, going through the usual laboratory routine, would not be available for playback until the following day. The actual procedure in cases of this sort is to operate two recording machines, one on regular recording to be developed at leisure for the final print, and the other on toe recording for the synchronous playbacks.

The third feature of toe recording, mentioned above, namely its use in scoring from sound tracks, is the nearest we have come so far to using this process for actual production work. The present tendency in scoring incidental music on pictures is to record the music only, in synchronism with the picture, and then, when a good take is obtained, use this sound track for dubbing under the dialogue, together with whatever other sound effects it is desired to add. This avoids the use of an expensive orchestra for long periods while experimenting with the balance between dialogue, music, and sound effects. In such cases it is again desirable to have the sound track available for reproduction as soon as possible, and toe recording has provided the solution. In these instances, toe recorded negatives have actually been dubbed into the final print with excellent results.

The fourth advantage of toe recording is its use in making frequency films. It has been found that the reproduction of constant tones from a toe recorded negative is remarkably steady. This has proved conclusively

that the printer introduces a marked variation in steadiness, due either to lack of good contact between negative and print, or to unsteadiness of the printer light. Ordinary negatives are, of course, not suitable for reproduction due to their distorted wave-form. Toe recorded negatives, however, since they provide a straight line relationship between exposure and transmission, give excellent wave-form, and are ideal for frequency films where steadiness of readings are important. In addition, a toe recorded negative gives better high frequency response than an ordinary print, to the extent of at least 4 db. at 6,000 cycles. This is due chiefly no doubt, to the elimination of the loss of definition caused by poor contact in the printer.

The fifth advantage of toe recording is that it gives more output level than a regular process print for the same recording level. This amounts to about 6 db. as a rule. An ordinary print should not have more than 25 per cent transmission for good quality. A toe recorded negative or print, on the other hand, gives its best quality at 50 per cent transmission. This difference would account for the 6 db. increase of level.

Disadvantages of toe recording

It is inevitable, of course, that toe recording should have some disadvantages, and while these are not very serious, they should in all fairness be mentioned here. The most serious objection which has been raised against toe recording is that the prints are too high in transmission to be durable enough for commercial release. We have not made sufficient tests along this line to verify this point. It is undoubtedly true, that a given amount of dirt on a print will have a more detrimental effect on a light print, than it will on a dark one. On the other hand, it would appear that scratches would be less noticeable on the light print.

Another objection which has been brought forth, is that the surface noise would be high due to the high transmission. This has not been borne out in practice, however. While the emission noise from the projector photo-electric cell does increase with increase of film transmission, the greater volume output of a toe recorded negative or print allows us to drop the fader setting about two points, so that the ratio of signal to noise remains about the same as it is in ordinary prints.

A third objection, which appears to be of rather minor importance, is that the average printer would have to be modified in order to reduce the light sufficiently to enable it to make prints of 50 per cent transmission through negatives of the same transmission.

As regards the range of modulation available in toe recording, which might appear to be rather limited when looking at an H & D curve, it is quite apparent from figures 3 and 4, that it is sufficiently long to accommodate about 90 per cent modulation of the light valve. In either system of recording we would inevitably run into curvature if the valve were to close completely. Repeated tests have shown conclusively that toe recording does not overload any more readily than does straight line recording. If but a fraction of the amount of thought and care given to the present system were expended upon a study of toe recording, we would undoubtedly obtain even better results with less trouble and expense than we do with the standard method of recording.

In closing, I wish to express my appreciation to Mr. H. A. Smith, of Electrical Research Products, Inc., for invaluable assistance and suggestions in developing this process.

Industrial uses of electron tubes

By W. R. G. BAKER¹
A. S. FITZGERALD²
and C. F. WHITNEY³

FEW engineers have thus far considered the thermionic tube as having any important applications in the field of power and industry other than in communication systems—telephone, carrier current, and space radio.

Every day, however, electron emitting devices are put to new uses in high voltage a.c. and d.c. switching; remote control circuits; voltage regulation of alternators; frequency control; rectification and inversion of currents; and control of industrial processes. With these devices currents can be interrupted instantly, and silently, without switches, contacts, or other mechanical features. The actuation of these electron tube systems may be brought about by several different physical effects. Operation may depend on changes in resistance, inductance, capacitance, phase angle, frequency, or temperature; it may also be controlled by sound, carrier current, space radio, or light. The quantities of power handled have increased from a few milliwatts to the order of many kilowatts; what the ultimate power limitations will be is difficult to predict.

Application of electron tubes to power control circuits involves problems unprecedented in ordinary engineering experience and very little information has been available to engineers interested in such developments as to the proper methods of design and application for obtaining effective and reliable operation. The territory,

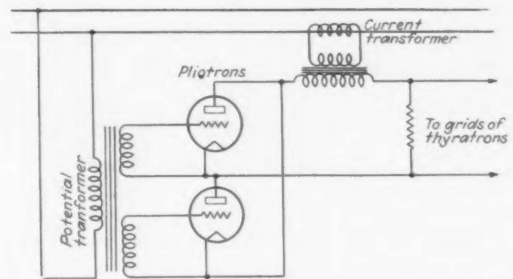

Fig. 1—Pliotron phase-controlled circuit

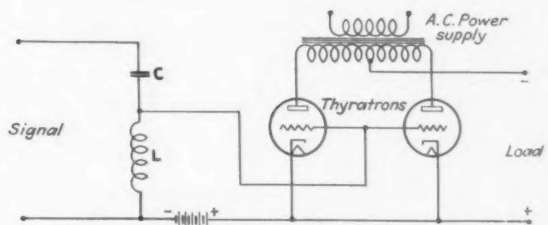

Fig. 3—Relay responsive to signals of a certain frequency

as it were, has been uncharted, and each individual development has been largely a pioneering undertaking. However, the technique of this special branch of engineering, while yet far from finality, is now beginning to take form.

It may be of interest to indicate briefly the principal objects which are aimed at in applying electron tubes to power control problems. The electron tube primarily possesses characteristics not available in the older forms of electrical apparatus such as, speed of operation, small control power, amplification properties, accurate response and quietness. These characteristics frequently fit the tube for uses impossible or impractical of attainment by other means.

As has been indicated, the principle of the electron tube technique is that these control circuits tend toward the elimination of all contacts, moving parts, and mechanical adjustments. The most favorable field of application for tubes at the present time seems to be presented

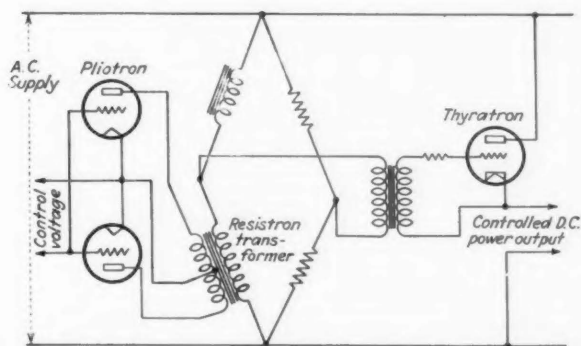

Fig. 2—Two bridge methods of controlling power by electron tubes

¹Vice-president in charge of manufacturing, RCA-Victor Company.

²Engineering Department, RCA-Victor Company.

³Radio Department, General Electric Company.

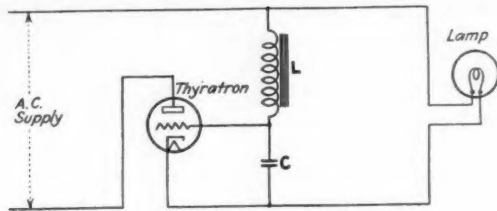

Fig. 4—Electron tube flasher circuit

by such devices as regulators and control systems, arrangements involving relays, contactors, circuit disconnecting devices, rheostats, and perhaps small motors for operating them, and other miscellaneous electro-mechanical items. In such apparatus are found contacts, moving parts, wearing surfaces, bearings, pivots, slip rings, brushes, and, to a certain extent, more or less accurate mechanical clearances and adjustments necessary to proper operation.

However well such apparatus may be built, contacts will burn, brushes must be replaced, and adjustments will work loose. When this occurs, the apparatus must be removed from service during the time required for dismantling and making the necessary replacements. It requires skilled services to carry out this work as well as to re-assemble and re-adjust the apparatus.

Tubes however can be mounted conveniently in sockets

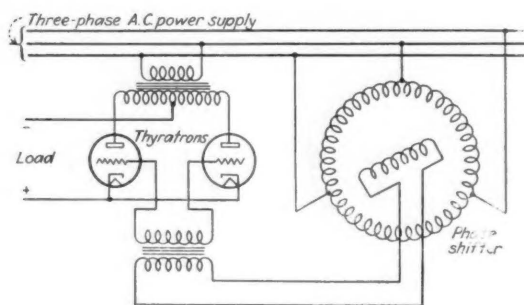

Fig. 5—Phase shifter of thyratrons for variable d.c. output

and may be instantly removed or replaced without interrupting service at all. Any circuit adjustments that need to be made from time to time, should operating conditions change, may be made by means of simple knobs and dials.

The other components of electron tube control circuits—resistors, capacitors, transformers, and reactors—have no moving parts and if properly designed, manufactured, and applied, can be made to operate reliably without service or attention. It is within the power of present day engineering methods to make such components capable of substantially indefinite life and constant characteristics.

Features of electron tubes

There are numerous forms of electron emitting devices used in the many ramifications of the electrical and radio industries but practically all of these can be classified as either vacuum tubes or gaseous discharge tubes. The vacuum tube, usually a three-element tube (Pliotron) is a low current device requiring a relatively high potential for plate supply. The gaseous tube is a different creation of which the Thyatron is the type tube. Its

usual function is to execute the action determined by the vacuum tube. If the latter can be thought of as a relay, the Thyatron is the contactor. It can handle considerable power on moderate voltages.

Another electron tube is the two-element rectifier, the earliest form of vacuum tube. It may be a high vacuum tube or it may have gas in desirable quantities in it.

Still another tube is the photo-tube which may be highly evacuated or may contain gas. Other tubes are the glow tube chiefly useful in voltage control; its action depending upon the definite ionization voltage of the contained gas and the four-element (screen-grid) tube, an outgrowth of the triode. It is essentially a high-resistance high-amplification tube.

Following are a few typical circuits utilizing electron tubes which will serve to give an idea of the scope and possibilities of these devices in power control. These circuits are not given as ideal representations of applications in every case but to illustrate in general the principles involved.

Phase-relation control

Figure 1 shows a phase control element in which the tube plate current is controlled by the phase relation between the voltage and current in a circuit. If the power factor is zero there is no resultant plate current; if the power factor changes from leading to lagging the plate current reverses accordingly. The grid excitation is of the same polarity for both tubes but the plates are excited in opposition. Thus with this arrangement the voltage across the resistance is zero when the power factor is zero, is positive when the power is positive and negative when the power reverses. It can be used in a similar way to indicate the phase relation of any two voltages. The voltage across the resistance may be used to control the grids of Thyratrons or additional vacuum tubes.

Vacuum tube control of Thyatron

In many control circuits the action of a variable resistance is desired but the usual types of rheostats, involving sliding contacts and mechanical movement are inapplicable. The ideal type of control device is represented by the vacuum tube in which the plate current may be controlled by the magnitude of the voltage applied to the grid and in which only a negligible amount of power is required to exercise this control. Unfortunately high vacuum tubes are not available which will furnish the amounts of power (at convenient voltages) frequently required in connection with regulating problems encountered in power engineering. The gas type of tube, on the other hand, has the disadvantage that the anode current cannot be controlled by the magnitude of the grid voltage. Circuits involving combinations of these two types of tubes will furnish exactly what is

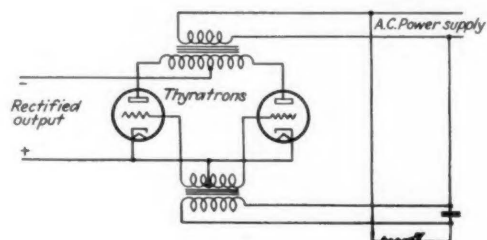

Fig. 6—Variable output secured by resistance control

required. All that is necessary is that variations in a control voltage be made to cause a phase shift of the voltage in one part of an electric circuit with respect to that in another part. A method of controlling power by means of a combination of Pliotrons and Thyratrons, along with an analogous manual system, is shown in Fig. 2.

In this system the Pliotrons are used as a variable impedance and although they are unidirectional in their effect, by means of a combination of two Pliotrons and a transformer, an effective a.c. impedance is obtained. A reactor is in series with this variable impedance and the bridge output voltage is impressed on the Thyratron grid. By these means, variations in the grid bias of the vacuum tubes will produce a variation in the circuit impedance and a shift in the phase of the voltage across the network. In this way by applying a suitable voltage to the grids of the vacuum tubes the phase relation of the Thyratron may be varied over a sufficient range to control completely the anode current. The effect gained when an a.c. plate voltage is used, is exactly the same as if we had a vacuum tube capable of handling, at moderate voltages, the heavy currents associated with the use of gas tubes.

A Thyratron tuned relay

The circuit shown in Fig. 3 employing two Thyratrons, functions as a tuned relay and furnishes a load with rectified a.c. The input circuit is tuned to the desired operating frequency by means of capacitance C and inductance L. The grids of the Thyratrons are normally biased negatively by a small battery. When the series circuit is resonant, maximum voltage exists across the coil L. The bias voltage is overcome, and the Thyratrons supply a rectified current output. This arrangement may be used for the remote control of circuits by carrier current.

A Thyratron flasher

An intermittent control circuit is shown in Fig. 4. This circuit furnishes a flashing device with no moving parts or contacts the period of which can be controlled by changing the size of either the capacitor or the inductance. The lamp is in the output circuit of the Thyratron and is lighted by the half-wave rectified output. When the light is on, the capacitor tends to charge up so as to apply a negative voltage to the grid. The charging current must flow through the inductance and is delayed depending upon the size of the inductance. When the voltage across the capacitor builds up, the Thyratron ceases to conduct and the light is turned off. Then the capacitor discharges through the inductance

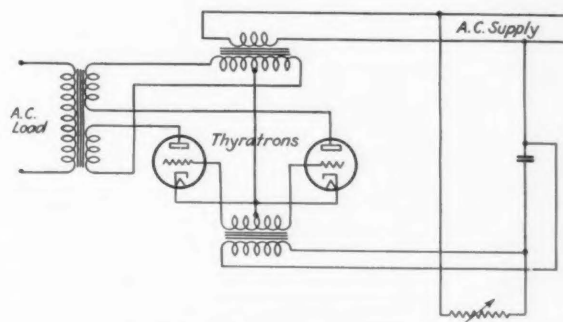

Fig. 7—Variable a.c. output secured by resistance control

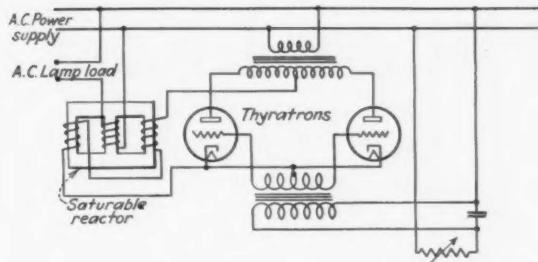

Fig. 8—Illumination control by electron tubes

slowly. This circuit is suitable for traffic beacons or sign flashers.

A circuit which is adapted to theater stage lighting control, as well as control of d.c. motors, is shown in Fig. 5. The circuit furnishes a full wave rectified current, the magnitude of which can be controlled by the angular setting of the phase shifter rotor. The principle of operation is a phase shift in the grid voltage with respect to the plate voltage. The power output of the rectifier can be varied from full load to zero in a fraction of a revolution of the rotor as determined by the number of poles on the phase shifter.

Methods of controlling output

The circuit shown in Fig. 6 is much the same as that of Fig. 5 except that the control is obtained by means of a variable resistance. A capacitor and resistor are connected in series across the supply voltage and the voltage across the capacitor is applied to the Thyratron grids. This voltage is in phase with the supply voltage if the resistance is zero and lags the supply voltage as the resistance is increased, up to a theoretical value of 90 degrees. In practice this range is not entirely available since for high values of resistance the voltage across the capacitor becomes reduced in magnitude. Manual control of the Thyratron current can be obtained by using a rheostat for this purpose, but the more valuable feature of resistance control resides in the possibilities which it provides of obtaining control by means not involving mechanical movement. Thus the Thyratron current can be controlled by any effect which can change resistance as for instance photoelectric action, thermal effects, or additional electron tubes.

A.C. output

The circuit shown in Fig. 7 is exactly the same as that shown in Fig. 6 except that the output is a.c. instead of d.c. The wave form is not sinusoidal but varies between a sine wave, when the current is a maximum, to a "chopped" wave when minimum current is allowed to flow.

Fig. 8 shows a circuit employing d.c. output from the Thyratrons as in the circuit of Fig. 6 and uses the rectified current to saturate the reactor which controls the power in the alternating current circuit. This method of control, like that of Fig. 7 involves wave form distortion. It can handle large amounts of power more conveniently than the circuit in Fig. 7 since in this case the tube rating need only be of the order of five per cent of the rating of the power load which is controlled. An installation utilizing this principle has been in service in the Chicago Civic Opera House for a number of months.

[Other circuits and uses of electron tubes by the present writers will appear in an early issue of ELECTRONICS.—EDITORS.]

HIGH LIGHTS ON ELECTRONIC

Practical measurements of ultra-violet intensity

Since last February an improved method of ultraviolet radiometry has been under investigation. It is an attempt to solve the problem of measuring, in energy units, the ultraviolet from an extended source (e.g., carbon arc and reflector) for which purpose a suitable selective radiometer is required, but none is available, and for which purpose a spectroradiometer is unsuitable, because it analyzes the radiation emanating from only a small portion of the source.

The present procedure is: (1) to mount a thermopile and a special photoelectric cell, side by side, on a spectropyrheliometer (*B. S. Sci. Paper No. 378*); (2) isolate the ultraviolet radiation of wave lengths 290 to 313 millimicrons; (3) measure the radiation intensity of wave lengths 290 to 313 by means of a photoelectric cell, covered with a rectangular slit that is of sufficient width to include these wave-lengths; (4) and similarly measure the radiation in this spectral range by means of a thermopile, covered with a slit that is cut into a template having the shape of the spectral response curve

characteristics of the photoelectric cell.

By calibrating the thermopile against a standard of radiation a similar calibration of the photoelectric cell is obtained in absolute measure. After that, the photoelectric cell, in its holder, may be exposed to the source under investigation.

The ideal photoelectric cell for this purpose is one that does not respond to wave lengths longer than about 315 millimicrons. During the past month, a photoelectric cell having closely these characteristics was investigated. Its sensitive surface consists of uranium. The cell is the invention of H. C. Rentschler, director of the Westinghouse Research Laboratory.

Oil-burner flame, through tube, controls fuel

Electrons harnessed in vacuum tubes have recently entered upon new usefulness as safety detectors to safeguard lives and property if the flame "goes out" in an oil-burner in home or apartment. Any such flame is slightly conductive of electricity. A very tiny current of electricity is therefore made to

MOISTURE IN LUMBER



Portable instrument devised by U. S. Bureau of Standards to measure moisture in lumber. Nail-like contacts are driven into board-end

flow through the flame and through a grid-glow tube. Should the furnace flame go out, this tiny current ceases, the grid-glow operates other electron tubes to release switches, and the fuel oil is automatically turned off.

Failure of the pilot flame for any reason thus results in the automatic stoppage of the oil flow, before any excess of oil can involve danger. Several hundreds of these electronic safeguards are now installed in household oil burners, and it is expected that thousands of homes and apartments will shortly go to this form of automatic electronic protection.

THYRATRON-CONTROLLED COLOR FLOODLIGHTING



This factory building of the Staley Company, Decatur, Ill., has its elaborate color-changing floodlighting controlled by three-element mercury tubes. Two hundred projectors are employed

Microphone listening posts

Telephones for wolf packs, so that the whereabouts of these animals may be discovered quickly and the packs exterminated by hunters, is the latest device proposed in Soviet Russia to help rid the vast plains of Siberia of the wolf menace, long an obstacle to settlement and safe travel. At intervals throughout regions where wolves are common, microphones like those used in radio, will be set up on trees or posts. These will be connected by tel-

DEVICES IN INDUSTRY + +

ephone wires or shortwave radio transmitters to one "central," where an operator will listen continually to sounds from the different microphones. Howls of wolves running in a pack often are audible for many miles, especially in a region like Siberia where few other noises exist. It is expected that the listener at the wolf "central" will hear through the nearest microphone the howls of any pack of these animals which enters the protected area. The operator then will communicate by telephone with the nearest patrol station or with groups of volunteer hunters living in the neighborhood who have arranged to answer such a summons.

+

"Talking lighthouses" to give positions to ships

Talking lighthouses to tell sailors miles out at sea just which lighthouse they are watching, or even to entertain these passing mariners with news of the day or weather forecasts, are possible by the modern process by which music, speech or any other sound may be "modulated" on a light beam, much as radio programs are sent out on the beams of radio waves from a broadcasting station. To the eye such a music-carrying beam looks quite as usual but if the beam is allowed to fall on a photoelectric cell, properly arranged with vacuum-tube amplifiers and other apparatus, the sound message on the lightbeam may be picked off and made audible to the mariner.

The beam from a revolving lighthouse, for example, might be made to sing a definite note whenever its rays fall on a small photo-electric cell mounted on a ship's bridge. Even the captain in his cabin thus would know, by the distinctive musical note of the beam, which lighthouse of several along a coast was then in sight. Such lighthouses now are distinguished by color or by the number and arrangement of flashes as the light revolves. The use of color necessitates decreased intensity of the light, since colored lights are not so bright as pure white ones. The recognition of lights by flashes requires considerable practice.

It might be easier therefore to have each lighthouse identify itself by a musical note or even by spoken words, although the former might require ship's captains to possess musical ears in addition to the manifold qualifications already necessary for that job.

"Deviometer" permits aviator to set course at angle

One of the auxiliary devices which the research division of the Aeronautics Branch, Department of Commerce, has developed to facilitate the use of the visual-type range beacon is an instrument called a "deviometer." By its use an airplane pilot can follow any chosen course, within limits, on either side of the equisignal line for which the beacon transmitter is adjusted.

The deviometer is essentially a device for changing the relative sensitivity of the two reeds of the vibrating-reed indicator, thereby permitting the pilot to fly courses (with equal reed deflections) along a line other than the equisignal line or zone set up by the beacon. In its simplest form, the deviometer consists of a resistor shunted across the coils actuating one of the two reeds, thereby reducing the driving current through the actuating coils and consequently the sensitivity of that reed.

The utility of the deviometer may be thus illustrated:

A pilot operating over a route between two airports, one of which has a radio range beacon but the other

lying 15 degrees to the left of the radio-served airway, simply adjusts the deviometer so that equal reed deflections are obtained along a line 15 degrees to the left of the true beacon course, and thereby lays out a new beacon course which he may use. The research division has made a number of tests on the deviometer in its various stages of development since this work was undertaken early last year and has within the past month lent one of these instruments to an air transport company for service tests.

Again, on a congested radio-served airway it becomes possible to reduce the hazards of collision between aircraft during conditions of poor visibility, by setting the deviometer to, say, 2 degrees to the right of the equisignal beacon course. Traffic in both directions will therefore fly on opposite sides of the equisignal course, and any possibility of head-on-collisions is thus precluded.

A third use for the deviometer is its aid to a pilot who has deviated considerably to the right or left of the true course in order to avoid a storm area or for other reasons. A much more satisfactory beacon service may then be obtained by adjusting the deviometer for equal deflections.

+ + +

VOICE, THROUGH AMPLIFIERS, CONTROLS VALVE

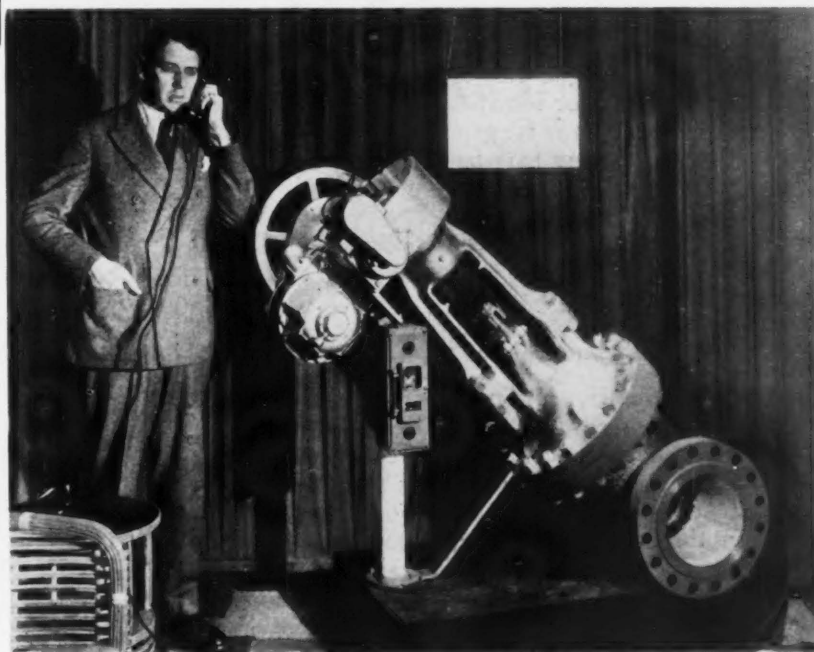

Payne Dean, president of the Limitorque Corporation, and his new telephone-controlled steam valve for power plants. The sound of the engineer's voice, through amplifying tubes, operates relay-switches, starting up the actuating motor and closing the valve

Variable-mu tetrodes in logarithmic recording

By STUART BALLANTINE

President, Boonton Research Corporation
Boonton, New Jersey

IN MANY kinds of electrical measurements a measuring device whose indications are proportional to the logarithm of the quantity under measurement is of decided convenience. This is particularly the case when it is desired to secure, by automatic means, records on a logarithmic scale of ordinates, covering perhaps two or more orders of magnitude. Examples of this are automatic recording of radio field-strength or of the frequency-response of loud speakers and amplifiers. For signal strength recording a range of a million (10^6x) is frequently required; for sound-pressure work a range of one thousand (10^3x) is generally sufficient. If desired such an instrument may be calibrated directly in *decibels*, and will in general be useful wherever these units are useful or preferred.

Several arrangements for logarithmic indication have been devised but they have not had sufficient range of operation for many uses.

The exponential tube

The invention by H. A. Snow of the variable-mu tube¹ and its development by Boonton Research Corporation has provided a device having precisely the logarithmic response characteristic which is needed for this type of indicator. The principles of construction embodied in the variable-mu tube make it possible to obtain plate-current, grid-voltage characteristics of a wide variety of shapes differing from the conventional $3/2$ - or 2 -power relations found in tubes of ordinary construction. Among the characteristics which have been

¹Stuart Ballantine and H. A. Snow; "Reduction of Distortion and Cross-Talk in Radio Receivers by Means of Variable-Mu Tetrodes"; *Contributions from Radio Frequency Laboratories*, No. 22, October 1930; *Proceedings Inst. Radio Eng.*, p. 2102, December, 1930.

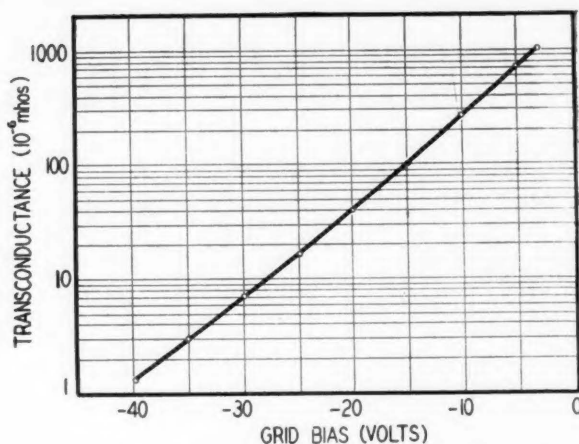

Fig. 1—Relation between transconductance and control grid bias in an exponential tetrode

obtained by Snow's method is one described by the expression:

$$i_p = Ae^{be_g} \quad (1)$$

In this tube, which we have termed an *exponential tube*, the plate-current i_p is an *exponential* function of the control-grid voltage e_g . The transconductance is likewise exponentially related to the control-grid bias:

$$s_m = \delta i_p / \delta e_g = Abe^{be_g} \quad (2)$$

By proper circuit design the amplification with a tetrode may be made proportional to the transconductance and will therefore also be an exponential function of the control-grid bias. The transconductance grid-bias characteristic of an average exponential Type 551 tube is shown in Fig. 1. To distinguish this tube from others of the variable-mu type it is called type 551E. Here the transconductance is closely an exponential function of grid bias over a range of three orders of magnitude, from 1 to 1000 micromhos.

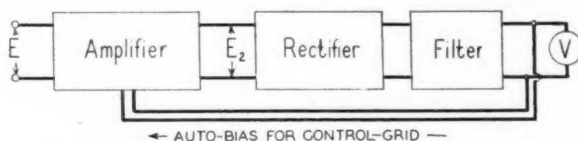

Fig. 2—Using the 551E exponential tube for logarithmic indication

The fundamental method of and structure for securing this type of characteristic was described at the Rochester Convention of the Institute of Radio Engineers, November 21, 1930. This structure is such that a different, or variable- mu-factor is obtained for the electrons emitted from various elements of the cathode surface. When the grid bias is low (e.g., near zero) current flows from all of these elements; as the grid bias increases negatively the current from those elements having the higher mu-factors is gradually and automatically cut off at a selected rate. By properly choosing the area and mu-factors of the elementary areas, characteristics of a wide variety of shapes can be obtained.

Theory of the logarithmic indicator

While originally designed for the reduction of distortion and cross-talk in radio receivers the Type 551E

exponential tube lends itself with perfect felicity to the design of a logarithmic indicating device capable of operation over ranges of magnitude up to a million to one. The method is illustrated schematically in Fig. 2. The amplifier comprises one or more exponential tubes, the number being chosen principally with regard to the range of a.c. voltage E_1 to be measured. The amplification is controlled by an automatic grid bias derived from a rectifier connected to the output terminals of the amplifier. The sensitivity of automatic control, and the cut-off of the rectifier, are such as to result in a constant a.c. output voltage E_2 being obtained over the range of input voltages to be measured. If now the values of the automatic grid bias are indicated by a voltmeter it can be shown that the deflection of this instrument will be proportional to the logarithm of the input voltage, by virtue of the exponential relation between the trans-conductance of the tube and the grid bias.

It may be of interest to consider the action of the automatic control system in more detail. The principle of deriving a bias voltage from a rectifier terminating an amplifier for the purpose of automatically altering the amplification is an old one² and has been employed for several years in broadcast receivers for the purpose of rendering the output independent of variations of signal voltage. For the analysis of the action of the control system a graphical method shown in Fig. 3 has been found convenient. The stable amplitudes of the output voltage as a function of input voltage during auto control can be derived from the equilibrium diagram, Fig. 3a, and are shown in the accompanying control diagram, Fig. 3b.

Let us represent by $E_c = f(E_2)$ the characteristic of the rectifier, i.e., the relation between the d.c. output voltage to be applied as an auto bias to the control grids of the amplifier tubes, and the applied alternating voltage E_2 . A low-pass filter is inserted between the rectifier and the amplifier grids to suppress alternating currents.

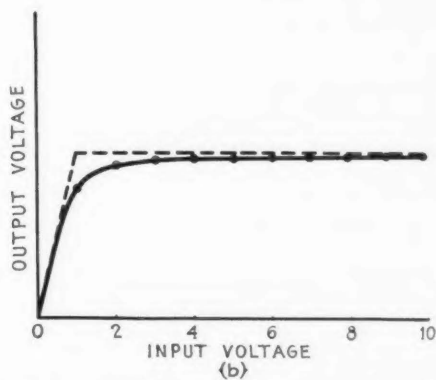

Fig. 3 (b) Relation between output and input voltages during auto-control

Let the relation between the control grid biases and total amplification of the amplifier be denoted by $A(E_c)$. Then the output voltage E_2 will be

$$E_2 = E_1 A(E_c) \quad (3)$$

Combining this with the rectifier characteristic:

$$E_c = f(E_2) \quad (4)$$

we have two simultaneous equations to be solved for the stable amplitudes. A graphical solution, using E_2 as parameter, is shown in Fig. 3a. Equation (1) gives a

²Ballantine, U. S. Patent No. 1,723,719.

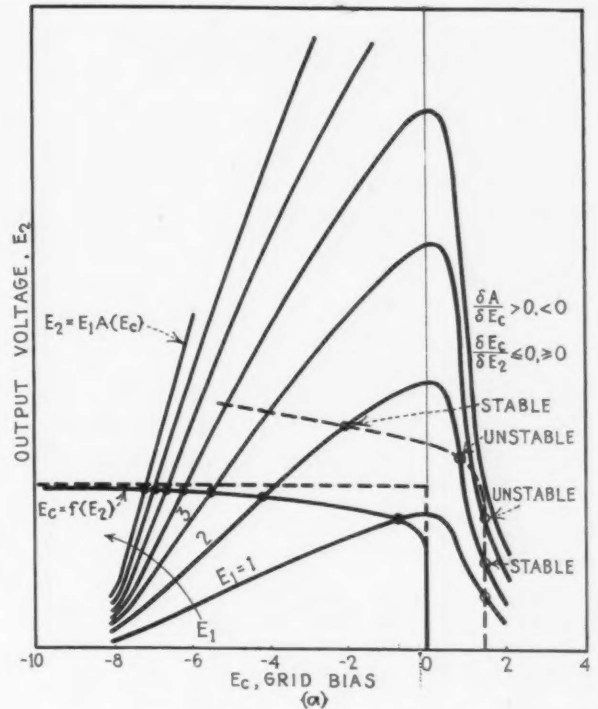

Fig. 3—(a) Equilibrium diagram for automatic amplification control system

set of curves each of which represents the output voltage for a given input voltage as a function of the control-grid bias. The intersection of these curves with the rectifier characteristic determines the possible output voltages and biases. Some of these points may be unstable as shown by the conditions for stability posted at the right-hand side of the diagram. All points on the solid rectifier curve are stable and represent controlled amplitudes. The relation between output and input voltages is of interest and can be derived from Fig. 3a and plotted as a control diagram in Fig. 3b. The rectifier system is usually provided with a polarizing voltage which defers its operation until the applied a.c. voltage reaches a certain level. The controlled output level may be adjusted by adjusting this polarizing voltage. If the rectifier system were infinitely sensitive, as shown by the dotted lines in Fig. 3a, we should obtain perfect control after the critical voltage is exceeded, as shown by the dotted lines in Fig. 3b. The activity, or sensitivity, of practical rectifiers may be improved by inserting an a.c. amplifier before the rectifier or a d.c. amplifier after it. Assuming that the control is approximately perfect and considering the special case of the exponential tube, equations (3) and (4) become by virtue of (2):

$$E_2 = E_1 A e^{nb E_c}; \quad (5)$$

$$E_2 = f(E_c) = \text{const.}; \quad (E_1 > E_2/A);$$

where n represents the number of amplifier tubes controlled. Solving for E_c :

$$E_c = -\frac{1}{nb} \log_e \frac{E_1 A}{E_2} \quad \text{if } E_1 > E_2/A. \quad (6)$$

Thus for all values of E_1 greater than the critical value required to start the control, E_2/A , the indications of a meter measuring E_c will vary as the logarithm of the

[continued on page 490]

Loud speaker deflection measurements

By RALPH P. GLOVER and
THEODORE A. HUNTER

Engineering Department,
Crosley Radio Corporation

AN IMPORTANT consideration in the design of radio and public address equipment is the reduction of distortion of the signal to a minimum. The quality of reproduction of such systems is determined by a number of complex factors, many of which are rather obscure. However, it seems to be thoroughly agreed that two important forms of distortion should be eliminated as far as possible if good reproduction is to be obtained. These are distortion due to (1) non-linear relation between input and output and (2) non-uniform transmission over the essential range of frequencies.

These considerations are especially important in loud-speaker design. Here the problem is one of translating a fluctuating electric current into a corresponding motion or disturbance of the surrounding air in the most faithful manner possible. If, for purposes of discussion, we assume that an ideal acoustic radiator is used, then there must be a linear relation between electric current and displacement of the diaphragm if the first type of distortion

▼

AN ingenious combination of electron tube apparatus and an Ames gauge enables irregularities in speaker drive rod movements to be measured; aids in speaker design; makes possible the physical position of an object to be determined to within 25 millionths of an inch.

▲

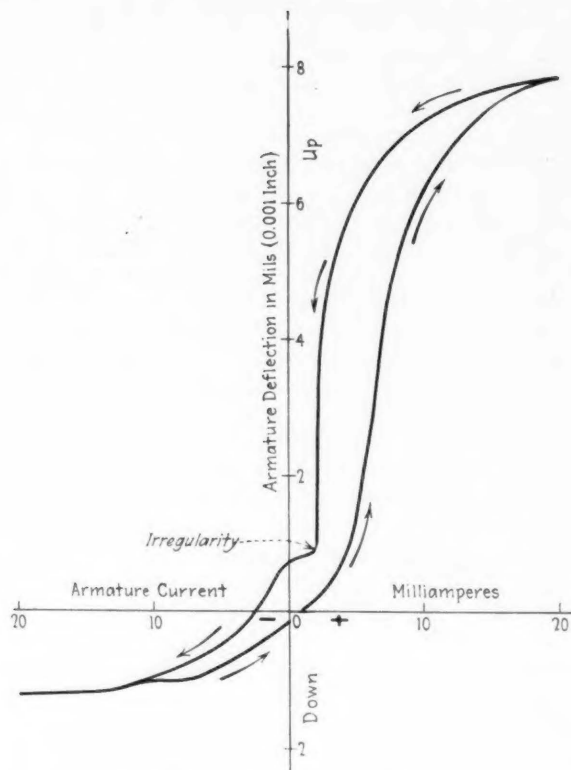

Fig. 1—Irregularity in speaker response

is to be eliminated. This condition is closely approximated in well-designed dynamic speakers. Magnetic speakers, on the other hand, have numerous points of design which may introduce considerable non-linear distortion. Saturation, hysteresis, magnetic unbalance, the use of damping cushions in the armature assembly and improper centering are frequently contributing factors.

If direct current is caused to flow through the armature winding, the resulting deflection of the armature should be proportional to the current both in magnitude and sense.

Poorly designed magnetic speakers depart considerably from this characteristic. The moving systems of such speakers follow the complicated variations in input which accompany speech or music very poorly and when other undesirable effects are present, as they usually are, the resulting quality may be fearful and wonderful.

Deflection measuring apparatus

Magnetic speakers vary in sensitivity over rather wide limits. A representative value, however, is about one one-thousandth inch of movement per milliampere of armature current. In investigating armature motions, it has been found that the equipment should be capable of measuring deflections at least as small as one ten-thousandth inch with a fair degree of precision.

The deflectometer shown in Fig. 3 was devised with these requirements in mind. It consists essentially of an Ames dial gauge, graduated in ten-thousandth inch divisions, mounted in a suitable fixture over the armature drive rod. In order that the pressure of the gauge foot on the drive rod might not produce misleading results and to provide for fine control, a screw adjustment was added to the gauge lever. The gauge was insulated from the base by a wooden fixture supported on heavy metal brackets. A small piece of micarta provided in-

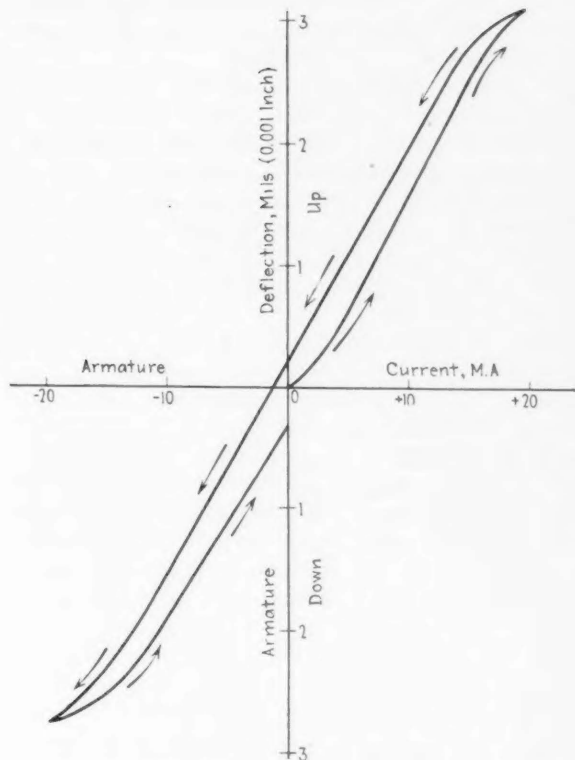

Fig. 2—Evidence of improved speaker characteristic; narrow, regular loops

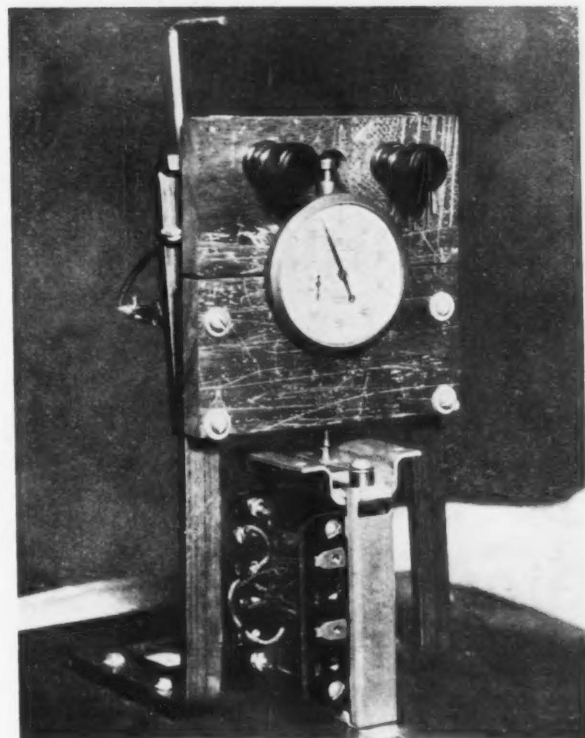

Fig. 3—Method of mounting displacement gauge

sulation between the adjusting screw and the gauge itself. In operation, readings were obtained by lowering the gauge foot with the adjusting screw until contact with the drive rod was made. Binding post terminals, connected to the gauge and to the metal base, were provided for a contact-indicating circuit.

A low-voltage lamp and battery were first tried as a means of indicating contact. It was soon found, however, that insufficient precision was obtained in this manner; the lamp would glow over a range of about .002 inches. The presence of contact resistance therefore ruled out any method which required an appreciable current to flow through the signal circuit.

The final circuit of Fig. 4 was obtained after some experimental work. A leak of 5 megohms resistance was connected across the input terminals of an electron tube voltmeter and the deflectometer circuit was connected across the leak with a 1.5-volt battery in series.

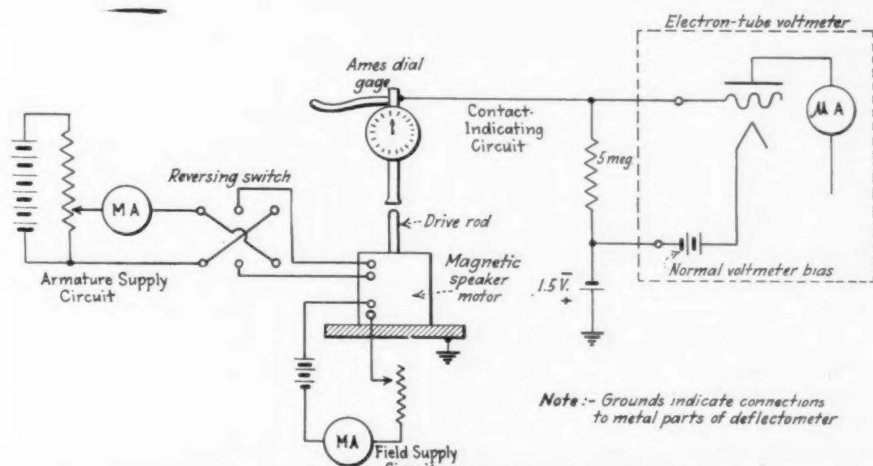

Fig. 4—Details of circuit for measuring deflections

Thus, when the gauge foot just touches the armature drive rod, the normal negative bias on the tube is reduced by 1.5 volts, resulting in a sudden upswing of the microammeter pointer. In practice it was found that the position of the drive rod could be determined to within one-quarter dial division or within .000025 inches. Further applications of this method will undoubtedly be found in the field of accurate measurements.

Some interesting experimental results have been obtained with deflectometer described. Figure 1 is a deflection curve taken on a magnetic motor unit in which the field was unbalanced and the armature was out of center. The effect of these improper conditions is clearly shown by the marked difference between upward and downward deflections for the same magnitude of armature current. The characteristic is a distorted hysteresis loop, as might be expected. Much of the hysteresis, however, is a mechanical effect. The irregularity indicated on the curve is quite likely due to longitudinal slipping of the armature in its supports. It is self-evident that a loud speaker exhibiting such a characteristic as this will produce enormous distortion.

Fig. 2 gives the deflection characteristic of a greatly improved speaker motor. The curve is nearly linear and the hysteresis effect is less pronounced. When accompanied by improvements in the transmission-frequency characteristic, very high-quality reproduction was secured. The value of the deflectometer in this development work cannot be over-estimated.

For the first time inspection of armature motion was possible.

The Circuit Court judges' opinions in the Langmuir high-vacuum patent case

THERE is now before the United States Supreme Court for acceptance, an appeal in a patent case of the widest importance to American industry—Langmuir high-vacuum tube patent. (No. 1,558,436.)

The Circuit Court of Appeals for the Third Circuit, has by a divided opinion of two to one, reversed the United States District Court which had held this patent to be invalid. The appeal from the Circuit Court's divided verdict is now before the Supreme Court for acceptance.

This case becomes of tremendous significance because of the wide variety of applications of high-vacuum tubes in radio, national defense, sound pictures, broadcasting, industrial control, telephony, musical instruments, power transmission, aviation, surgery and therapeutics, metallurgy, etc., and the control it will accordingly effect on great future industries.

As has been pointed out by commentators on both sides, it is very important to American commerce that on the highest possible court authority, the fairest possible adjudication be reached at the earliest possible time, based upon a complete study of the facts. The opinions handed down by the Circuit Court justices, two supporting and one denying validity of the patent, present in themselves a thorough analysis of the technical aspects of the art surrounding the patent, and constitute real contributions to the literature of the subject. They are quoted in part in the following:

Opinions of Judges Buffington and Davis

"IN litigation over a patent of great commercial value, the case, on re-argument, narrowed to the simple question of the patent paternity of what is known commercially as the Langmuir tube. The Court below held the tube had no patent paternity and to that question we now address ourselves.

"Laying aside the technical language and scientific discussion and confining ourselves to simple statement, the Langmuir tube is a tube in which the gaseous conductor incident to a Fleming valve and a DeForest audion is dispensed with and a vacuum substituted therefor.

"Turning to the question on which the validity of the patent depends, we inquire as to its usefulness, for the constitutional power to create the monopoly of a patent in that regard conditioned "to promote the progress of . . . useful arts" and the Congressional enactment in pursuance of the Constitution is that "any per-

son who has . . . discovered any new and useful" etc. For in the final analysis, use, usefulness, is the acid test, the *sine qua non* of patent grant.

The unusual degree of usefulness of the tube may be assumed. The defendant (De Forest Radio Company) by its use evidences its usefulness and has adopted it and ceased making "gaseous type tubes." The Court below described the tube, and we agree with its estimate, as an agency which "because of its stability, reproducibility and power has made possible radio broadcasting, modern radio reception and long distance telephony."

Seeing we are dealing with a progressive step which next to the telegraph, the telephone and the wireless, is probably one of the most far reaching and beneficent in human progress, there can be no question of a non-gaseous, vacuum tube's usefulness. Such being the case, is it novel? The simple fact is that we see such a tube in universal use today. Indeed the fact that a non-gaseous vacuum tube makes possible the present improved practice shows that such practice did not exist before the Langmuir tube and that no other device or devices, all important as they may have been in their spheres, did either singly or collectively produce the present practice. The patent office recognized that. In the opinion of The Board of Examiners they found, in affirming the decision of the Examiner of Interferences, that "Langmuir was the first to conceive and the first to reduce."

Langmuir's radical departure

Now as it seems to us, the art, although it did not exactly know how the gas in gaseous tubes acted and just why it was able to so conduct, nevertheless continued to use it and regarded it as the indispensable means of conducting. As against this firmly entrenched teaching and practice of the art, Langmuir's suggestion of eliminating gas as a conductor was a radical change and even more so was not the substitution of some other tangible conductor, but the disclosure of supplanting the tangible gaseous conductor by the intangible conductor of a vacuum. Vacuums, per se, were of course known. De Forest's audion and Fleming's valve were equally known, but the suggestion of dispensing with gas and utilizing a vacuum between the two was as novel in practice as it was unlooked for in result. That Langmuir's use of high vacua did not appeal to so practical and eminent a scientist as de Forest was evidenced by his statement, heretofore quoted, made even after Langmuir had made known his process publicly,— "I believe, however, that Dr. Langmuir has, by working into these extremely high vacua and the high potentials necessitated thereby, pursued the less promising of two paths of research." If it was an obvious thing, for the ordinary art to do away with gas and substitute high vacua therefor, surely such an extraordinary mind in that art as de Forest, when confronted with the substitution, would not have pronounced high vacua a mistaken path.

It is contended and the Court below so held, that all that Langmuir did was simply to vary in degree the prior use of the vacuum and that a mere difference in degree does not constitute invention. Assuming the correctness of this general proposition, we think it is not applicable to the present case. In considering change in degree, the test is not the quantum or minimum of change made but the quantum of change in function and result which such change, great or small, effects. A

great change may effect but a slight change in function and result, while a slight change may effect a radical difference in function and effect. The effect, the practical progress and use in the arts, are the aim and end of patent grants and where great results follow a change, the slightness of the change tends to emphasize and make all the more remarkable, unexpected and inventive the disproportionate result the slight change effects. A vacuum, or indeed change of vacuum, isolated and standing by itself, is not the Langmuir invention, but it is a working tube in which all the elements, cathode, plate, vacuum, so co-ordinate and interwork that current flow is not affected by gas. We say not affected by gas because of necessity an absolute vacuum is an impossibility, but the degree of vacuum is such the current flow is no longer objectionably affected by gas. Just what the degree of vacuum shall be is dependent on several elements and, as stated in the patent, cannot be exactly stated. In that regard the specification says: "The evacuation of the device should be preferably carried to a pressure as low as a few hundredths of a micron, or even lower, but no definite limits can be assigned."

Judge Woolley's dissenting opinion

I AM constrained to dissent from the judgment of the court holding the Langmuir patent No. 1,558,436 valid. I have the same trouble that other tribunals have had throughout the twelve years of the patent prosecution and five years of the patent's life in finding precisely what Langmuir invented. My trouble, like that of the others, has been increased by the difficulty which attorneys for the patent have had in defining the invention and by the difference between their definitions and the claims of the patent.

The invention relates to an electron discharge device comprising the familiar vacuum tube in which the customary electric current is carried by electrons and relates particularly to a vacuum space so free from gases as to avoid ionization. If the parts and principles of the mechanical construction were new and the gas evacuation old, there might be invention; if the structure were old and the gas evacuation were new, there might be invention. But the essential parts and principles of the mechanism were old, and high vacuum in the tube also was old.

Importance of the patent

The de Forest patent expired in 1925, the year in which the patent in suit—issued to Langmuir, assignor to the General Electric company. The Langmuir patent now completely covers the field previously occupied by the audion of the expired de Forest patent, and will, on the decree of this court continue to cover it for twelve years more; hence the importance of this litigation.

When the patent came into litigation in this case in the District Court of the United States for the District of Delaware the learned trial judge, having trouble with the claims endeavored to get a definition of the invention, asking time and again as did this court on appeal: If not high vacuum, what is the invention? An answer to this question seemingly had its difficulties. The plaintiff could not say that the invention was high vacuum alone or in combination with Fleming and de Forest parts alone. It was forced to

admit that the Langmuir device included all these old elements but claimed it included "something else."

"The Langmuir invention is a coordination of elements having a new functional relation between the various factors, producing a new result. It is not a matter merely of maintaining a certain vacuum, far less of producing a certain vacuum which will be destroyed the moment the tube begins to operate. It involves primarily a relation between the shape, size, and space relation or 'geometry' of the parts of the tube and nature and pressure of the gas therein contained, coordinated and adjusted with respect to the conditions of the electric circuit."

The court did not adopt the definition of coordinating elements with functional relations but, stating that a non-gaseous electron discharge device did not exist before Langmuir, found the invention to reside in his producing a non-gaseous tube in place of a gaseous tube of the prior art, or in other words in substituting a high vacuum for a low vacuum, the very thing the plaintiff was forced to avoid in its definition because it was old. I agree with the court's succinct definition of the invention, but as the invention so defined was old I cannot agree to hold a patent for it valid.

Langmuir must have known that a non-gaseous tube was old for otherwise, if he had believed he was the first to conceive and make one he could and doubtless would have claimed it in a half dozen words; "a non-gaseous discharge tube," or "an electrical discharge device with a high vacuum tube."

Prior publications and patents contradict, I think, the court's holding that Langmuir was the first to make and invent a non-gaseous tube. They are so numerous that it would not be permissible to quote them in an opinion.

On these references I stand; and on them I would hold the patent invalid for want of invention.

Radio; product of many inventors

Much litigation in respect to the radio art has drifted to this circuit. Oddly enough, in every case the plaintiff has claimed for his invention the whole credit for its growth. I am satisfied from the number of cases we have heard that the whole credit for the amazing advance of the radio art cannot be given to any one invention or even to a few of them. In truth the art is the product of innumerable impulses. At one time there were seven thousand applications for patents pending in the radio section of the Patent Office.

Important and indeed great as some of these inventions were, no one of them is entitled to all credit for the what has been accomplished in this great art, for the art has been impelled forward by hundreds of inventors and thousands of skilled workers. What Langmuir claims have done—procured pure electron discharge above ionization voltages in tubes of the de Forest type—appears to me to be the natural growth of the art, begun by others before Langmuir and by them reduced to practice with means then available, and developed to their later perfection.

I thought after the argument and still think, the Langmuir patent invalid because of lack of invention and prior use. If I am wrong and the patent really involves invention, then again, I think it not valid for, as I read the evidence, Langmuir was not the first and original inventor. On this point—I refer and subscribe to the opinion of Judge Morris—that, if invention, Arnold was the first and original inventor.

An electronic a.c. galvanometer

By **LEONARD TULAUSKAS**

Assistant Radio Engineer
United Air Cleaner Corporation

THE electrical quantities most frequently measured in radio laboratories are resistance, capacitance, and inductance. Resistance measurements are simple to make and a Wheatstone bridge for very accurate work is fairly inexpensive. Impedance bridges are only slightly more complicated except for the null indicator. In the d.c. bridge, a simple d.c. millivoltmeter or microammeter is used as a balance indicator. The impedance bridge requires a more elaborate arrangement, as there has been no simple a.c. galvanometer suitable for such work.

A usual type of laboratory inductance bridge is shown in Fig. 1. A pair of headphones is used as a balance indicator. When the arms of the bridge have been adjusted so that no sound is heard in the phones, the value of the inductance being measured is given as

$$L_x = L_s \frac{R_2}{R_1}$$

R is used only to adjust the power factor in the reactive arms of the bridge and does not enter into the equation for inductance.

It will be found, generally, that the sensitivity of a high grade pair of earphones is not great enough to allow of an accurate balance. This difficulty has been overcome in the past by connecting two or three stages of amplification between the output of the bridge and the headphones. However, if the noise level of the room

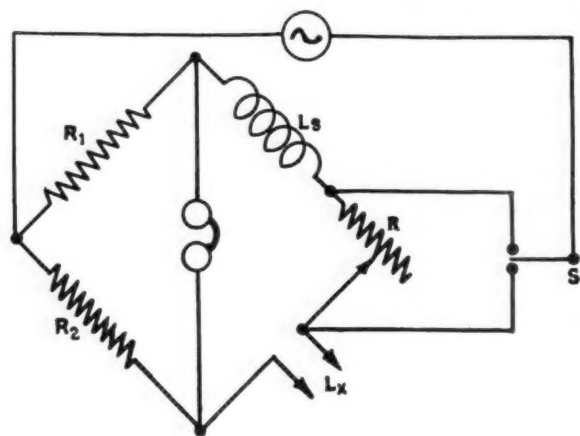

Fig. 1—The familiar Wheatstone bridge circuit

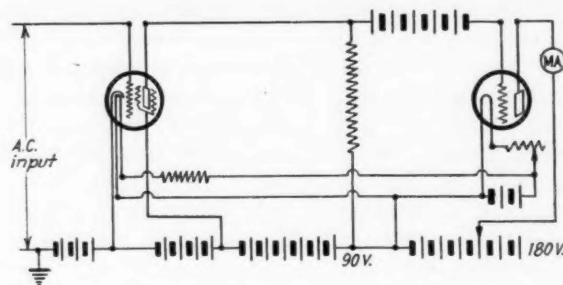

Fig. 2—An amplifier-detector for bridge work

is high, it will be found that such a scheme quickly fatigues the ears of the operator and deadens them to small differences in volume. It appears, that for precision measurements a visual indicating device is essential.

For large reactances, a ballistic galvanometer is quite satisfactory, but it is totally unsuited for the small quantities frequently encountered. Another defect, is that the galvanometer constant must be determined anew each time the instrument is used.

If the bridge is excited by a comparatively low frequency, say 1,000 hertz, then it is possible to use a vibration or resonance galvanometer as an indicator. Such a galvanometer is provided with an adjustment for varying the period of the moving coil within certain

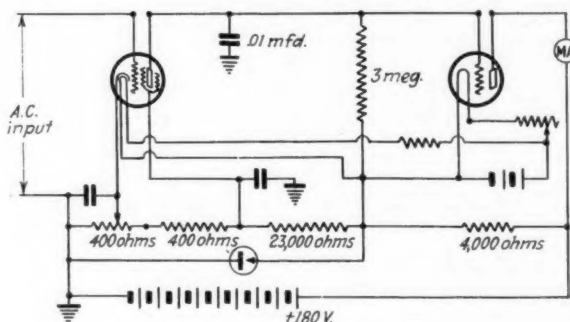

Fig. 3—Addition of voltage regulator and self-bias apparatus

limits, and the amount of power required for its operation is extremely small. Unfortunately, the period of the moving system changes with time and requires continual readjustment. Its chief disadvantage is its susceptibility to burnout with any great overload. This alone makes it unsuited for most impedance bridges.

Thermionic balance indicators

As there seemed to be nothing suitable for the purpose, it was decided to experiment with VT voltmeter arrangements with the idea of producing an instrument of variable sensitivity which would be just suited to impedance bridges.

The '24 heater-type screen-grid tube was selected first, as previous experiments with it as an automatic volume control tube in radio receivers indicated that it was inherently suited to such a purpose. After a number of attempts to use it alone, the idea was discarded and the tube was used in conjunction with a direct coupled '12A tube as an amplifier. The original circuit is shown in Fig. 2. By proper adjustment of the operating potentials, it was found that full scale deflection of the milliammeter could be obtained with an input of but 5 milli-

volts. Note that any input to the rectifier will cause an increase in plate current. This in turn increases the voltage drop across the load resistor and as this voltage drop is part of the grid bias on the amplifier tube, the plate current of the latter decreases. For this reason, heavy overloads will not cause any damage whatsoever.

Operation from a.c.

While the arrangement just discussed was deemed satisfactory as regards sensitivity, yet there was too much variation in the plate current of the amplifier with no input applied to the device. By removing the amplifier grid bias battery, the arrangement was stabilized somewhat but the sensitivity was greatly reduced. Apparently, there was no reason why this should occur, so the circuit was carefully studied and it was discovered that the capacity to ground of the grid battery had been acting as an a.c. by-pass for the unrectified component of the plate circuit of the screen-grid tube. A 0.01 mfd. condenser from plate to ground restored the sensitivity to the original value. The addition of a voltage-regulator tube and the use of a common battery for all the circuits rendered the device very stable indeed. The arrangement then was as shown in Fig. 3.

It was desired, now, to make the device operative from the a.c. power lines. Accordingly, a '27 type tube was substituted for the '12A tube and a transformer was used to heat these tubes. A variation of 10 per cent in the line voltage caused very little change in operating characteristics of the tubes. The entire unit was then operated from a.c. through a rectifier but instability of operation occurred again. The sensitivity, also, was slightly reduced.

Use as a production type bridge

After considerable experimentation, the final circuit was evolved and is shown in Fig. 4 as part of a production type inductance bridge. The amplifier ahead of the a.c. galvanometer insures high sensitivity regardless of the variations in the tubes which are used. It also acts as a relatively low input impedance to the screen-grid tube and prevents that tube from responding to parasitic voltages which tend to accumulate on the grid.

The final circuit amounts to a medium- μ tube ('27) resistance-coupled to the screen-grid tube which, direct coupled to the parallel '27 type tubes, acts as the galvanometer. Two glow tubes in series across a 180-volt supply maintains voltages on the proper parts of the circuit



Fig. 5—Photograph of inductance bridge in shielded box

at a constant value contributing to the stability of the entire instrument. The power supply consisted of a conventional thermionic rectifier and filter system.

Photographs of the completed bridge show the disposition of the apparatus. As this particular bridge is operated at 1,000 hertz, the shielding is not particularly good. It should be noted, however, that with adequate shielding the bridge may be operated at radio frequencies with no change in the a.c. galvanometer whatsoever.

Some observations on the sensitivity of this instrument may prove of interest at this point. One case is very striking. A General Radio capacity bridge, type 383-B, used for measuring small capacities to 600 mmfds. is equipped with a large main dial and a smaller vernier dial. With headphones attached to the output of that bridge an apparent null was obtained and no change could be heard by moving the vernier dial from one end of the scale to the other. The a.c. galvanometer was then connected in place of the phones and a movement of one division on the vernier dial resulted in a 20 per cent change in the reading of the milliammeter.

In conclusion, the writer wishes to express his appreciation to Mr. H. Dressel of the Hammond Clock Company, Chicago, for his original suggestions and comments and to Mr. A. C. Ten Cate of this company who successfully applied this thermionic a.c. galvanometer to various types of production test equipment.

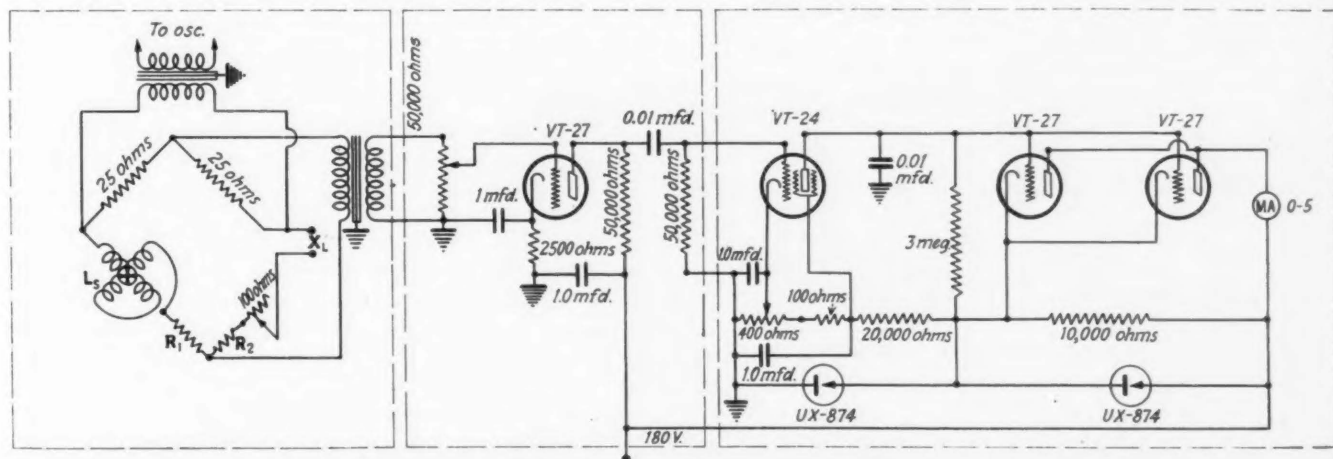

Fig. 4—The complete circuit diagram of the instrument. The power supply may be a conventional rectifier-filter system

electronics

McGraw-Hill Publishing Company, Inc.
Tenth Avenue at 36th Street
New York City

O. H. CALDWELL, *Editor*

Volume II — JANUARY, 1931 — Number 1



"More radio-set" for less money

THE radio designer and manufacturer can point to some striking progress in the technical production of radio sets during the past five years.

Receiver sensitivity and quality have been multiplied at least eight times, meanwhile mass manufacture has made it possible to sell such receivers at about one-third the amount they would have cost five years ago.

In point of weight, receivers generally have been cut about in two, as the result of developments in the use of lighter materials and improved circuit design. But contrary to this weight-ratio trend, of course, midgets represent really the highest cost per pound of any class of sets, and illustrate the commercial pressure on set design to produce "more radio set" for a given low price.

Incidentally it may be remarked that present sets sell over the counter at somewhere near the price of beefsteaks in the butcher shop—from 45 to 50 cents per pound!



The "no man's land"

BETWEEN the very short wave lengths used in radio experimental work and the heat waves, lies a neglected and almost unnoticed gap. The upper limit of heat or infra-red rays is in the neighborhood of 0.02 cm.; the short-wave work

does not go much below 5 meters. Of the nature of the radiation within these limits, generally speaking, nobody knows anything. For the past ten years or so a few scattered experimenters have investigated ultra-high frequency oscillations, but their results have not been conclusive or exhaustive. Oscillations at a wave length of less than a meter are not difficult to generate; waves of 43 cm. have been produced.

It is unfortunate that practically no quantitative work has been done in measuring signal strength at appreciable distances on wave lengths of the order of a few meters. The knowledge of the causes of the oscillations is meagre and the factors controlling them are poorly defined. The lone adventurer has done his part. It is now high time for an organized searching party to investigate the topography and chart the terrain of this "no man's land" of the spectrum.



A quarter century of the triode

THIS month marks the 25-year anniversary of the invention of the three-electrode vacuum tube by Dr. Lee de Forest (in January, 1906). It was indisputably de Forest's triode or "audion" which initiated the present widespread development and almost limitless possibilities of the electron tube. Surely an invention of such humanitarian importance, distinguishes its author as one of humanity's greatest benefactors.

Not only did de Forest give to radio and electronics one of its basic devices, but there is also abundant evidence of his restless ingenuity and unceasing industry in finding new ways to put his invention to work. He was the pioneer experimental broadcaster, years before the commercial broadcasting era. He early saw the application of the oscillating audion to electrical musical instruments. And he took out one of the first patents for a high-frequency "cold cautery" or radio knife.

This versatility and disposition to pioneer into new and untried fields, prove the intense inventive spirit and initiative back of Dr. de Forest's work which created the audion and resulted in a whole host of electronic progeny.

Radio and automobile contrasts

RADIO men often compare the automotive industry with the radio industry in considering future trends in radio manufacture and marketing. But we have in the automobile one factor that does not appear as an important one in radio. It is that of style obsolescence.

Try to drive an expensive car purchased ten years ago, and expect by so doing to attract any favorable attention as being up-to-date! The cars of only a few years ago are exceedingly obsolete in style, as compared with present cars. But the radio set is hidden in the home. It does not have the outside display that the automobile does. Its obsolescence from a style viewpoint therefore is much less evident.

The automobile has another very important factor which requires that its design be kept up-to-date. Safety on the public highway is a necessity. Cars that do not comply with a reasonable degree of safety, measured in terms of conditions as they exist today—not in terms of conditions as they existed a few years ago—are ruled off the highway. Two-wheel brake cars require frequent inspection and adjustment in many states to pass the road test that may be given a car at any time by state inspectors. Many an old radio set is giving satisfactory service today from a selectivity viewpoint due only to the fact that the signal intensity at the point where the set is being used is very low. Many of these sets, having very poor selectivity characteristics, would be made obsolete by higher signal intensities. This is a

natural result of the advance of the art, and should furnish a fertile field for additional sales of receivers. There is no reason to expect sets purchased years ago to be used as the standard for reception conditions today.



Tube life vs. maximum economy

A QUESTION most frequently asked tube engineers by industrialists regards tube life. This is a heritage of their radio experience when users have been educated to expect a certain life, say 1,000 hours, regardless of the cost of the tube, or regardless of how poorly the tube may be operating at the end of 1,000 hours.

What is important is "economical tube life." Engineers can build tubes for practically any requirement as to expected life. It is important to note that most economic life expectation does not necessarily mean maximum life. A 100-watt amplifier tube operated in a radio receiver where a maximum of five watts is required might last three times as long as a tube designed for the purpose. But it would not be economical.

Industrial users of vacuum tubes will find that tube engineers will design tubes and application engineers will apply tubes in such a manner that the maximum economy to the user will result.

"Electronics" staff begins Volume II.

FOLLOWING an established McGraw-Hill Company policy that each January issue shall review the history of the publication, personnel, etc., the reader is here reminded that *Electronics* began publishing in April, 1930, with its present organization: O. H. Caldwell, editor; Dr. Franklin S. Irby and Keith Henney, associate editors; Harry Phillips, art director, and Helen Sheridan, make-up editor. Maurice Clements, business manager; Julian H. Wesseler, manager, Research & Promotion, and M. E. Herring, publishing director. With this issue *Electronics* begins Volume II.

Shown in the picture, grouped around a 100-kw. broadcasting tube, from left to right, are H. Phillips, M. Clements, K. Henney, Helen Sheridan, F. S. Irby and O. H. Caldwell.



REVIEW OF ELECTRONIC LITERATURE HERE AND ABROAD

The human body as antenna

[RAAB] Curious observations on reception with the finger touching the antenna binding-post of a small receiver. Reception is stated to be good, and it is particularly emphasized that interference (e.g. from ultra-violet ray apparatus) is greatly reduced in relation to signal strength: the body thus appears to act as something more than a mere condenser-antenna.—*Radio B.F. f.A., Stuttgart, December, 1930, republication from Aerztlichen Rundschau.*

Interference hunting and removal

[CONRAD] A description of the methods developed by the German post-office and broadcast organizations, and of the special apparatus used in the search for sources of electrical interference.—*Funk, Berlin, November 21 and 28, 1930.*

Experimental results with ultra-short waves

[BEAUVAIS] Waves of 15 to 18 centimeters were produced by a tube with negative plate and positive grid. The diagram of the receiver is as shown, the wave-length of the oscillatory circuit being from 20 to 60 meters: a super-regenerative effect results. Great difficulty was found in obtaining suitable tubes owing to variations in the manufactured products. Experiments with various types of mirrors are described, great exactitude being obtain-

able in goniometry (sharpness of 2 to 3 degrees) by using a parabolic mirror at the receiver. The emitted beam is also very sharp with such a mirror at the sending station, a movement of 2 degrees being readily detected at the receiver. Distances of 23 kilometers were covered (power not stated) and the presence of fog had no effect.—*L'Onde Electrique, Paris, October, 1930, published November 18.*

Logarithmic tube characteristics

[FASAL] Continuation of article (these Digests December 1930). Methods of reading other quantities, e.g., the correct grid polarizing voltage, from these curves are explained. Particularly valuable results are obtainable if such curves be plotted for screen-grid tubes, but against screen-grid voltages instead of against anode voltages. The "Güte" curve (product of amplification factor and mutual conductance) may also advantageously be plotted for these tubes in view of its marked maximum value for a certain screen-grid voltage: this curve is readily plotted since it suffices to read the vertical distance between the "Durchgriff" (reciprocal of amplification factor) and mutual conductance curves. The contrast between the complicated curves of the type generally employed and those proposed is very striking in the case of screen-grid tubes. Methods of directly obtaining the curves are given. The application to pentodes is also described, the curves in this case being plotted against anode voltages as in the case of triodes.—*Funk, Berlin, December, 1930.*

The Glow-lamp for measuring and testing

[BRANDES] A standard glow-lamp (neon lamp) with the normal circuit gives a convenient and exact means of comparing condensers and resistances

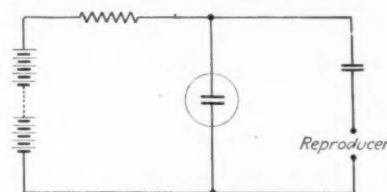

with known standards, as also of testing the insulation of antennas, transformers, etc., and for continuity tests.—*Funk, Berlin, November 14, 1930.*

The grid Dynatron

[YOJI ITO] In this arrangement an oscillatory circuit is connected in the grid lead and the negative resistance due to secondary emission with a high positive anode voltage is utilized, as contrasted with the normal or "anode Dynatron" arrangement where the oscillatory circuit is in the anode lead and a high positive grid potential is used. If a second oscillatory circuit be added in the anode lead of the grid dynatron, the frequency is still controlled by the grid circuit, this having valuable practical applications. A full theoretical discussion follows, with curves.—*E.N.T., Berlin, November, 1930.*

Radio broadcasting on short waves

[MEISSNER AND LIBAU] A non-technical article, interesting as being the first publication of the fact (well known in technical circles) that the Heinrich-Hertz Institute, the German Postal Department Laboratories, and the Telefunken Company have been experimenting on the re-broadcasting within cities of distant stations, on waves below 10 meters. Interference is stated to be less troublesome than on longer waves, the effect of buildings is negligible, a simple detector and one stage of audio-frequency suffices, and practically no antenna or counterpoise are required.—*Sendung, Berlin, November 21, 1930.*

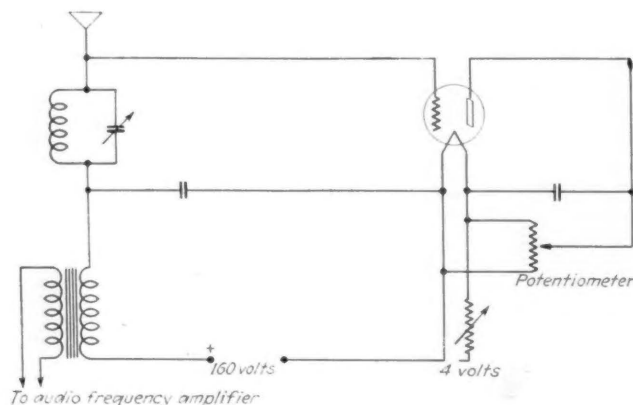

Receiver for ultra-short waves; note positive grid

Ignix rectifying tube

[LA PORTE] Unusually full description of a French commercial product: tungsten filament in argon at 15 to 20 millimeters pressure.—*Radioelectricite, Paris, December, 1930.*

+

Inertia of gas-filled phototubes

[SCHRODER AND LUBSZYNSKI] Gas-filled photocells are more than 10 times more sensitive than vacuum cells, but show a lag which makes them unsuitable for rapidly fluctuating illuminations. Their high sensitivity is due to the production of an avalanche of ions, and the charged particles disappear less rapidly than they are formed, particularly if high anode voltages have to be supplied in order to get enough sensitivity. In some gases the effect was found to be more pronounced than in others. In order to get a comparison a discharge tube with two plane electrodes a few mm. apart was filled with helium, neon, argon and a mixture of argon and hydrogen at low pressures; a discharge is passed through the gas and the conductivity of the gas is measured after the discharge has been stopped. When a potential of 30 volts is applied for measuring the conductivity, ions can be detected in helium and neon four and five minutes after the discharge has been interrupted. No trace of charged particles could be detected in a mixture of argon and a small percentage of hydrogen, even when the conductivity was measured one second after the interruption of the discharge. The lag of cells must be due to the formation of metastable atoms, not to the rate of recombination. No metastable atoms can persist in argon when hydrogen is present; this is well shown by light absorption experiments. Photoelectric cells treated with hydrogen and filled with argon give faithful reproduction up to 10,000 hertz. Cells filled with pure hydrogen are still better in this respect and could be used in television experiments for up to 70,000 changes per second. But further work is necessary because the hydrogen pressure could not be kept sufficiently constant at different temperatures.—*Physikalische Zeitschrift, October, 1930.*

+

Cold cathode tubes

[UNSIGNED] Discussion of the von Ardenne photo-electrically actuated tubes, based on his article in *Z.f.Hf.T.*, October (these Digests December) but interesting as containing photographs of tubes and associated apparatus and a circuit diagram.—*Radio B.F.f.A., Stuttgart, December, 1930.*

ELECTRONICS — January, 1931

"Arcotrons"

TELEFUNKEN GRIDLESS TUBES

Type	Color	No.	E_p	I_p	M_u	G_m	I_f	Remark
201	Blue	..	150 V	2.20	10.0	120	0.24	Hard
301	Red	1*	50 V	1.42	0	0	0.26	Soft
301	Red	2**	50 V	0.90	1	1	0.28	Soft
			$E_F = 1.00$	$E_F = 150$ or 50	$E_g = 0$			

*Gas content ionizes at $E_p = 70$; I_p read at $E_p = 50$

**Gas content ionizes at $E_p = 85$; I_p read at $E_p = 50$

+

Tubes with external grids

For some time Telefunken (Germany) has been experimenting with tubes in which the control element is placed external to the usual bulb. In October

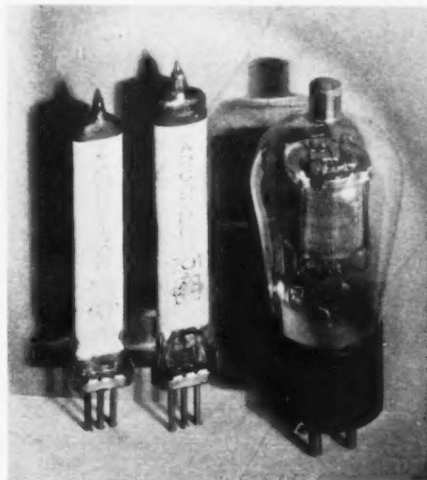

Electronics—these pages—some description of these tubes was given. The photograph illustrated here and the characteristics above are presented through the courtesy of George Lewis of Arcoturus Radio Tube Company.

+

Recent developments in direction-finding apparatus

[R. H. BARFIELD.] A modified Adcock system was compared with a rotating loop system over a long period of time. The Adcock system was the better. This system was then used to receive signals from a transmitter attached to a kite; it was found that there was a residual instrumental error in the presence of downcoming waves; a further modification of the system is described which, it is hoped, will eliminate this error.

The second part of the paper is devoted to description of two portable short-wave direction finding receivers, one of each of the above types. It is again found that the Adcock type is preferable for all distances greater than the skip-distance.—*Journal, Institute of Electrical Engineers, August, 1930.*

+

German tube constants

$$\text{Durchgriff (D)} = \frac{I}{\mu}$$

$$\text{Steilheit (S)} = \text{Mutual Conductance.}$$

$$\text{Güte} = \mu S$$

Improved vacuum-tube d.c. voltmeters

[BERL, HERBERTZ WAHLIG; WULFF AND KORDATZKY] When properly used, the vacuum tube is an ideal d.c. voltmeter, as it measures voltages without absorbing current and is superior in this respect to the most expensive meters. The fact that no current needs to flow even during the preliminary adjustments is very valuable in electrometric titration and hydrogen ion concentration work. The drawbacks are the necessity of having to compensate the initial anode current until it becomes zero and allows the full sensitivity of the meters to be used, and the shift of the galvanometer zero.

In order to reduce the initial deflection to zero the first named authors use the entire potential drop in the filament in place of a compensating battery. This increases at the same time the stability of the instrument, because if after prolonged functioning the potential of the A battery changes, the emission of the filament decreases, but the compensating voltage is diminished at the same time. The proposed arrangement is more sensitive than the one having a rheostat in the filament circuit.

The last named authors retain the compensating battery; its potential is chosen so that without requiring resistance it compensates the drop in a high resistance through which the whole anode current flows. Consequently the meter has to be placed in one of the leads from the compensating battery. This battery is shunted by a high resistance so that with prolonged functioning its potential falls at the same rate as that of the other batteries. An adjustment of the shunt becomes necessary after about 12 hours of continuous use (recording). A galvanometer sensitive to currents of the order of 10^{-7} to 10^{-8} can be used.—*Die Chemische Fabrik, No. 35 to 38, No. 45 and 46, 1930.*

483

+ NEW PRODUCTS

THE MANUFACTURERS OFFER

This section is prepared by the editors of *Electronics* purely as a service to readers. Its aim is to present announcements of all new products, devices and materials of interest in the field of the paper. All items are published solely as news, and without any charge or any advertising consideration whatsoever.

Low capacity mica condensers

AIMING AT LOWER PRICE without sacrificing essential characteristics, the Dubilier Condenser Corporation, 4377 Bronx Blvd., New York City, now announces the new Dubilier Micadon 701 condenser. This is a small mica condenser made in the usual low capacities for receiving circuits, and now available in quantity lots to radio

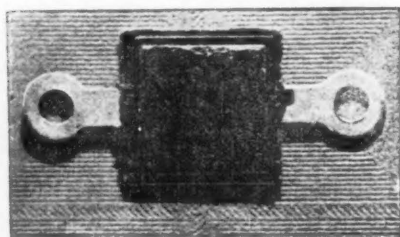

and allied manufacturers. It comprises a mica and metal foil unit covered top and bottom with thin sheets of bakelite, firmly sealed together and thoroughly impregnated for complete proof against moisture. Since the r.f. losses in receiving condensers are largely a question of the amount of insulating material surrounding the condenser, the minimum of insulation in the present Dubilier micadon design insures minimum r.f. losses.—*Electronics*, January, 1931.

Bulletin on small power motors

A CATALOGUE DESCRIBING the various types of small motors ranging in size from 1/150 hp. to 2 hp. has just been issued by the Westinghouse Electric and Manufacturing Company, East Pittsburgh, Pa. Detailed description of the various types of a.c. and d.c. motors coming within these limits are given, including, application, operation and construction. In many applications the motors parts are supplied to the appliance manufacturers who build them into the frames of their machines or other units as required. This feature is particularly desirable in moving picture projection units, turntable design, etc. Anyone considering the application of motors of this size will find this bulletin useful.—*Electronics*, January, 1931.

Tipless tube machine

FOR USE OF RADIO TUBE and lamp manufacturers a machine that takes straight glass tubes and bends the ends, which when made into stems, blows a hole in the side of the flare wall, has been announced by the Eisler Electric Corporation, 744 South 13th St.,

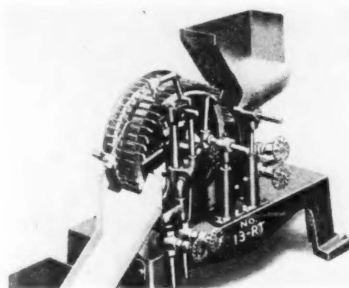

Newark, N. J. The machine requires one 1/4 hp. motor. Its net weight is 245 lb., and it has a production capacity of 2,000 units per hour.—*Electronics*, January, 1931.

Laminated insulating material

THE MICA INSULATOR COMPANY, 200 Varick St., New York City, has announced a new insulating material which is of laminated Bakelite, known as Lamicaid. It is produced in sixteen grades and in a variety of finishes and colors. Colors available include natural, black, brown, grain mahogany, grain walnut and burl walnut. The variety of thicknesses and finishes makes this material applicable to a great many uses in the electronics field. This material will stand relatively high temperature and certain grades machine well and can be punched with simple dies.—*Electronics*, January, 1931.

Radio coils

MANY TYPES OF self-supporting coil windings are made by the Easton Coil Company, P. O. Box 237, Easton, Pa. These coils are made to specification or designed for specific requirements. The coil windings usually furnished are of the multiple paper inter-layer type, assuring uniform layer winding at a minimum cost. Among the types of coil windings are those made for audio transformers, B eliminator transformers, chokes, X-ray apparatus, loud speakers, and telephone and telegraph apparatus. Easton's engineering and factory staffs, with a combined experience of 35 years, are ready to cooperate on problems relating to the design, construction, and use of electrical coil windings.—*Electronics*, January, 1931.

Two-stage amplifier unit

FOR INSTALLATIONS requiring only an output up to 4.8 watts, the Thomas Engineering and Manufacturing Company, St. Charles, Ill., has announced a Model A-245 two stage amplifier. It

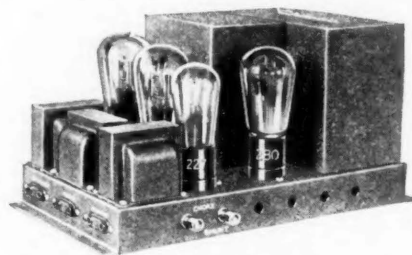

uses one 227 tube in the first stage, two 245 tubes in push-pull in the power stage and a 280 tube for a rectifier. This company also manufactures a line of condensers, transformers, coils, loudspeakers and electrical pick-ups.—*Electronics*, January, 1931.

Hand microphone

WITH AN OVERALL LENGTH of only 6½ inches, weighing 10 ounces and small enough to be slipped easily into the pocket is the new Model 29 microphone announced by the Kellogg Switchboard and Supply Company, 1066 West Adams St., Chicago, Ill. The handle

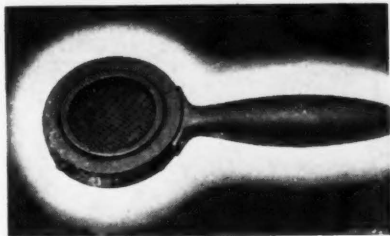

is cast from aluminum with a case of formed brass combining lightness and strength in its construction. The diaphragm is made from high grade phosphor bronze and is gold plated to insure good contact. The carbon button is insulated from the back with moulded Kellite, a phenol resin composition of high insulating qualities. This unit is particularly adapted for home recording use.—*Electronics, January, 1931.*

Special alloys for electrical and radio uses

CROMIC "c" is one of many special metals developed by the National Harris Wire Company, 221 Verona Ave., Newark, N. J., particularly suited for electric heaters, radio rheostats, potentiometers, etc., and other appliances which operate at temperatures up to 1,650° F. Another special resistance wire made by this company is known as Novar (no variation). Its specific resistance is 296 ohms per circular mil-foot, and its constant resistance over the temperature range from 60° to 600° F. makes it most suitable for apparatus requiring accuracy and permanency such as electrical measuring and testing instruments, resistance coils, thermo-couples, etc.—*Electronics, January, 1931.*

Quartz crystal frequency control unit

DEVELOPED TO ACCOMMODATE quartz plates which are ground to oscillate at frequencies from 750 to 2,000 kc. is the No. D-90715 Quartz Crystal Frequency Control unit of the Western Electric Company, 50 Church St., New York City. This control may be used in apparatus which uses a frequency multiplier where the desired output frequency will be a multiple of the crystal control frequency. In this plug-in unit are placed heater circuits, a mercury thermostat and the quartz crystal with its contact electrodes. The

Western Electric No. D-90011 Quartz Crystal Frequency Control unit is also available for quartz plates ground to oscillate at frequencies from 2,000 to 4,000 kc. These units are particularly applicable in aviation radio telephone communication systems.—*Electronics, January, 1931.*

Multi-tap switches

MULTI-TAP SWITCHES comprising 2-3-4-5-12 and 24 positions with 1 to 4 circuits have been announced by the Soreng-Manegold Company, 771 Mather St., Chicago, Ill. These switches are particularly adapted to hotel radio systems where centralized control is used. They are also applicable on combination phonographs, etc. They have positive positioning features, and are simply designed and constructed with double wiping contacts.—*Electronics, January, 1931.*

Unitary structure principle incorporated in tube design

IN ORDER TO INSURE uniformity of inter-electrode capacities, immunity to short-circuited electrodes and other advantages the Arcturus Radio Tube Company, Newark, N. J., has adopted a unitary structure principle in designing its tubes. All electrodes in such a tube are supported at both ends by yokes in planes perpendicular to the axis of the electrodes. As an example of this construction in the Arcturus Type 127

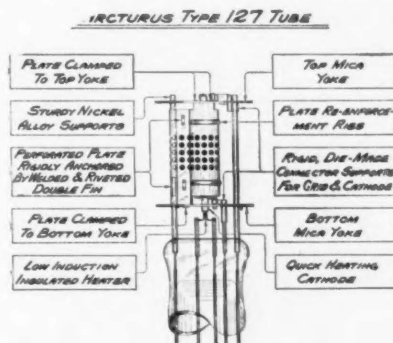

detector and amplifier the plate is a rigid cylinder of nickel perforated to permit radiation of heat and ribbed to increase its sturdiness. A mica yoke is clamped to the top and another to the bottom of this plate. The grid and cathode are secured to and automatically spaced by them in relation to each other and to the plate with the precision of the die upon which these yokes are blanked. It is claimed that such construction results in virtually "matched" tubes and lack of microphonic and other tube noises.—*Electronics, January, 1931.*

Volume control unit

COMBINING SIMPLICITY and accuracy in design with ruggedness is claimed for a volume control unit announced by the Wirt Company, 5221 Greene St., Germantown, Philadelphia, Pa.

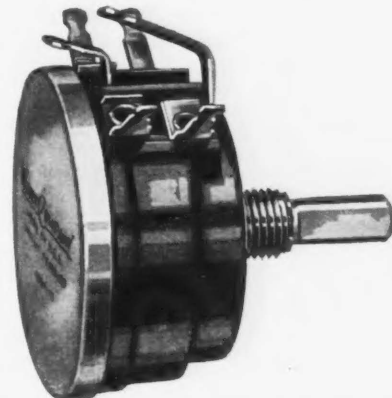

This is dual wire-wound control unit, completely housed in a bakelite case which protects it from the outside elements; and it is practically noiseless. The diameter of this control is 1½ inches and it is one inch deep. The unit is available in a black finish. The Wirt Company will be glad to furnish further details.—*Electronics, January, 1931.*

Bulletin on sound equipment

A BULLETIN has just been issued by the Polymet Manufacturing Corporation, 829 East 134th St., New York City, covering the complete line of sound equipment manufactured by this organization. A full description of their amplifiers and component parts, especially designed to meet the specifications for rugged sound equipment is given. This company has recently organized a sound equipment division to take care of special requirements in the sound field. Copies of this bulletin may be obtained by writing to the company direct.—*Electronics, January, 1931.*

Direct-coupled power amplifier

TWO POWER AMPLIFIERS utilizing the Loftin-White direct coupled system, have recently been announced by Electrad Inc., 173 Varick St., New York City. The Electrad C-250 amplifier provides 10.35 watts output with only 0.3 volt input and power consumption of only 160 watts. This amplifier unit includes tone control and hum compensator. It is completely assembled on a metal sub-panel and uses one 224, two 250 and two 281 tubes. The Electrad A-250 amplifier provides 4.6 watts output with .28 volts input and with a power consumption of 85 watts.—*Electronics, January, 1931.*

Two-button hand microphone

DESIGNED ESPECIALLY FOR home recording devices, industrial and home sound-picture machines and portable public address systems is the two-button hand microphone announced by Ellis Electrical Laboratory, 337 West Madison St., Chicago, Ill. This unit employs adjustable buttons as used in the



regular Ellis broadcast type microphones. It is claimed to have a distinct advantage over single button hand microphones. This unit is $6\frac{1}{2}$ inches long, head $2\frac{7}{8}$ inches in diameter, and $1\frac{3}{8}$ inches thick. List price \$25.00. The three-conductor flexible cord furnished at \$1.00 list price. — *Electronics, January, 1931.*

Phonograph pick-up

INCORPORATING A NEW METHOD of suspension and design is claimed for the new Hydro Sound Head, announced by the Unit Reproducer Company, 822 Merchants Road, Rochester, N. Y. This differs from other pick-ups in pole piece and armature design and suspension of the armature in the magnetic circuit. The new armature, it is claimed, has only one resonance period. Two small rubber bearings, $\frac{1}{2}$ in. square and $\frac{3}{8}$ in. thick, are used to produce brilliance in the highs and overtones, and to make reproduction more colorful. Three different types of pick-ups, each serving a different purpose, are available. One is for talking pictures, one for phonograph combinations, and one for broadcasting stations and engineering laboratories. — *Electronics, January, 1931.*

Plug socket for protection

FOR PROTECTING FILTER condensers and resistors, when the speaker field and voice coil connections are broken, a new plug and receptacle has been designed by the H. H. Eby Mfg. Company, 22nd St. and Lehigh Ave., Philadelphia, Pa. The Eby method of shorting two of the contacts when the plug is removed, makes the prongs of the plug inaccessible while they are making contact. This feature, plus the insulation of the plug, has induced approval by the Underwriters' Laboratories. The Model 2080 Plug is also ideal for speaker connections in sets using the Pentode tube.

When this tube is used, field connections, when they are broken, must be shorted to prevent damage to the tube. Separate plugs, similar in construction to the Model 2080, with the base arranged to fit any standard UX and UY sockets, are also available. — *Electronics, January, 1931.*

Universal high-voltage testing set

FOR LIGHT TESTING in either the factory or laboratory where potentials from 500 to 20,000 volts at 1 kva. are required an accurate testing set of flexible design has been announced by the American Transformer Company, 179 Emmet St., Newark, N. J. This model known as AmerTran. Type TS-15A operates from 110 volts 60 cycle a.c. and contains a special air-cooled testing transformer with a four-section secondary winding which permits of obtaining three different voltages at full output—5,000, 10,000 and 20,000. In addition the equipment includes a wire-wound potentiometer for adjusting the voltage to any value between zero and maximum, the exact value being indicated by a precision double-range voltmeter. — *Electronics, January, 1931.*

Automatic record changer

AN AUTOMATIC RECORD CHANGER which plays ten 10-inch or 12-inch records is manufactured by the Capehart Corporation, Fort Wayne, Ind. The base dimensions of this unit are $14\frac{1}{4}$ " x $14\frac{1}{4}$ " x $\frac{5}{8}$ " with height from top of mounting board to top of nut on record magazine $6\frac{3}{4}$ ".

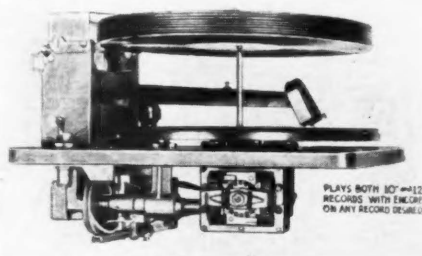

This base will mount in a compartment as small as $14\frac{3}{4}$ " x $14\frac{3}{4}$ " x 7". It is supplied with or without pick-up. This record changer is so designed that a double throw master switch can be supplied and placed at some convenient location so that when it is desired to shut off the phonograph it will finish out the record and return the tone arm to the extreme outside or open position. Records can then be changed without having to touch tone arm by hand. — *Electronics, January, 1931.*

Slide-wire rheostat and potentiometer

A PERCENTAGE OF resistance scale and a contact screw are incorporated in the slide wire rheostat and potentiometer brought out by Ohmite Manufacturing Company, 636 North Albany Ave., Chicago, Ill. Percentage of resistance is indicated by a scale across the top of the frame. This enables one



to obtain a close approximation of the resistance in the circuit without having to measure it on a bridge. The contact screw allows the operator to set the phosphor bronze spring tightly at any desired point, making certain of accurate consecutive readings. Ten different values of resistance units from 100 ohms to 100,000 ohms are available. — *Electronics, January, 1931.*

Mixing panel

DESIGNED FOR simultaneous mixing of three 200 ohm. input sources is the type 3D mixing panel manufactured by Jenkins and Adair, Inc., 3333 Belmont Ave., Chicago, Ill. The output impedance is approximately 200 ohms. This output can be worked into a load of most any impedance by means of a suitable transformer. Each channel is provided with an individual input key, the operation of which causes no change in the level of any other panel that may be in operation. Each channel is also provided with current measuring jacks, battery key, and rheostat for current adjustment when carbon microphones are used. — *Electronics, January, 1931.*

Bulletin on testing instruments

FOR MANUFACTURERS OF radio receivers, parts and electronic tube equipment an interesting bulletin describing the various types of testing instruments built by the Jewell Electrical Instrument Co., 1640 Walnut St., Chicago, Ill., has been published by this company. The following types of testing instruments are described in complete detail: ohmmeters, volt-ohmmeters, limit bridge, combination bridge, multi-range voltmeter, V.T. voltmeter, tube checkers, test panels, set analyzer, condenser checker, capacity meter, magnet tester, wire size indicator, galvanometer and oscillators. Copies of this bulletin will be gladly furnished on request. — *Electronics, January, 1931.*

PATENTS

IN THE FIELD OF ELECTRONICS

A list of patents (up to Jan. 6) granted by the United States Patent Office, chosen by the editors of *Electronics* for their interest to workers in the fields of the radio, visio, audio and industrial applications of the vacuum tube

Detection, Modulation, Amplification, Etc.

Amplifier. A combination of a vacuum tube and a device possessing capacitance, which supplies a variable voltage to the vacuum tube input. The output of the tube has an impedance which neutralizes the effect of any variation in frequency of the input voltage. A. B. Bedford, assigned to G. E. Co. No. 1,784,653.

Modulator. In series with the grid leak of an oscillator is a vacuum tube whose internal resistance can be varied by a modulating tube. J. J. Numans, assigned to RCA. No. 1,784,610.

Oscillograph. A vacuum tube is used as a step-down device to operate an oscillograph. The input circuit of the tube is the plate-filament, while the output is the grid-filament circuit. F. E. Terman, assigned to Wired Radio, Inc. No. 1,784,119.

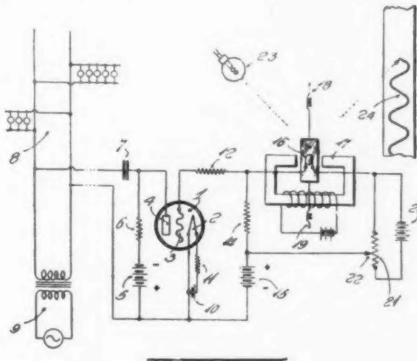

Constant frequency source. A tuning fork, amplifier, etc., for supplying constant frequency waves. W. A. Morrison, assigned to B.T.L. Inc. No. 1,784,844.

Rectifier. A cold cathode rectifier in which one of the electrodes is of limited area type. Frank Gray, assigned to W. E. Co. No. 1,784,869.

Gas-filled vacuum tube. A barrier between the anodes and separated from the anodes a distance comparable to the mean free distance of the gas. F. Meyer and H. J. Spanner, Berlin, Germany, assigned to Electrons, Inc. No. 1,784,877.

Frequency converter. Two tubes in a kind of push-pull circuit are arranged so that pulsating current of one frequency is converted to pulsating current of another frequency. Their output differentially feeds an antenna or other load. Paul D. Flehr, San Francisco, Cal. No. 1,784,228.

Radio receiver. Incoming oscillations cause a vacuum tube circuit to oscillate. These oscillations are transferred to the plate circuit of another tube. E. von Arco, assigned to Gesellschaft für Drahtlose Telegraphie, Berlin, Germany. No. 1,784,506.

Signalling system. Two vacuum tubes connected in cascade, arranged so that oscillation in one tube may be modulated by the other through a modulating device, say a microphone. W. A. Polson, assigned to G. E. Co. No. 1,784,645.

Superheterodyne receiver. Modulated radio frequency signals are amplified and then passed into a frequency changing system where a super-audible frequency is delivered to a resonant circuit. The resonant voltage rise across this circuit is impressed on an electrostatic loud speaker which functions as detector to produce sound from the beat frequency. A. F. Van Dyck, assigned to RCA. No. 1,784,210.

Keying system. An oscillating tube having a condenser shunted by a leak in the grid lead. Across this resistance is a key in series with two radio frequency chokes. W. Moser and E. Tod, Berlin, Germany, assigned to Gesellschaft für Drahtlose Telegraphie. No. 1,786,257.

Oscillation preventor. In a Rice-neutralized amplifier, oscillation frequently takes place whose frequency is governed by the leakage inductance of the input coil and the capacities across this inductance. A means of preventing this oscillation is an additional winding as shown. H. C. Silent, assigned to A. T. & T. Co. No. 1,785,819.

Magnetic modulator. A method of applying two currents to a magnetic device; the impedances of the sources and of the device are matched, so that maximum transfer of energy occurs when the second source currents are supplied through the modulator. Eugene Peterson, assigned to B.T.L. Inc. No. 1,784,879.

Modulation. A system of intermediate frequency modulation inside a radio frequency modulator tube. Otto Schriever, assigned to Telefunken. No. 1,786,579.

Apparatus for Electronic Circuits

Electrical filter. Elements exhibiting a considerable variation in resistance in response to comparatively small changes in applied e.m.f. are placed across a filter system for removing variations in output of a rectifier. T. H. Geiger, and L. O. Grondahl, assigned to the Union Switch & Signal Co. No. 1,784,004.

Load regulating system. Two sources of current connected in parallel, and means for maintaining a pre-determined division of loads between sources. Resistors with different temperature coefficients are connected to the sources, so that certain percentage changes in differences between the output current produce a greater per cent change in the potential difference between pre-determined points. Vacuum tubes are used in the method. E. R. McDonald, assigned to G. E. Co. No. 1,786,311.

Loud speaker amplifier. A combination of loud speaker of the type described in No. 1,784,517, and a push-pull amplifier. C. L. Farrand, assigned to Farrand Inductor Corp., Jersey City, N. J. No. 1,784,486.

Battery-charging system. A means of changing the charging current into a battery at pre-determined time intervals. J. L. Woodbridge, Philadelphia, Pa. No. 1,786,280.

Inductor loud speaker. A loud speaker motor, comprising a reciprocating armature unit, steel magnet structure, etc. C. L. Farrand, assigned to Farrand Inductor Corp., Jersey City, N. J. No. 1,784,517.

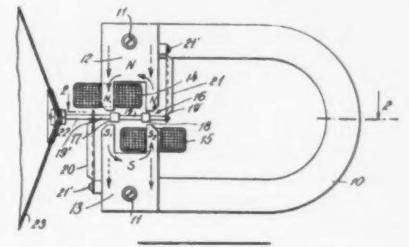

Sound Pictures and Acoustics

Multiple sound record apparatus. Housing for a plurality of photo-cells, lens systems and sound record. Light from a single source is directed through a single pair of lens upon the record. F. H. Owens, New York, N. Y. No. 1,786,027.

Light source housing. Housing construction which enables two sides of the box to be swung open for easy access to the apparatus. F. H. Owens, New York, N. Y. No. 1,786,026.

Optical system. Optical system involving source of light, lens, slits and photo-cells of the usual type. F. H. Owens, New York, N. Y. No. 1,786,025.

Method of cutting phonograph records. A method of cutting sound reproducing grooves in a phonograph record, and then subjecting these grooves to a cutting tool whose speed is varied in accordance with the character of the material to be recorded. E. J. Quinby, assigned to RCA. No. 1,785,047.

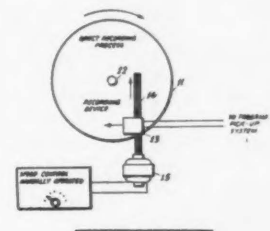

Sound recording system. In recording sound from a pick-up device at a distance from the recording mechanism, a means of automatically varying the gains in the recording circuit in anticipation of changes in the amplitude of the current from the pick-up device. E. C. Wente, assigned to B.T.L. Inc. No. 1,784,858.

Re-recorder. Sounds of long duration are recorded on successive records, then transferred to one disc by vacuum tube

PATENTS—

means, the second disc turning at a lower speed than the originals. Frank L. Dyes, New York, N. Y. No. 1,783,498.

Inductive light source. Sound waves modulate a high frequency current which flows through a coil surrounding a source of light thereby modulating the light. Theodore W. Case, assigned to Case Research Laboratory, Inc., Auburn, N. Y. No. 1,785,070.

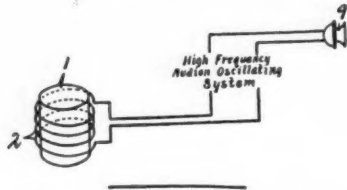

Electrically transmitting and reproducing sound. Sound is translated into modulated currents which are amplified and volume frequency distortion compensated. J. L. Reynolds, assigned to ERPI. No. 1,785,048.

Sound reproducing system. Part of the output from a sound record is rectified and used to excite a magnetron whose output is connected to a loudspeaker. A. Keller, assigned to B.T.L. Inc. No. 1,784,839.

Communication Circuits

Frequency-delay measuring circuit. Upon the sending end of a transmission circuit are impressed distinct single frequency currents. At the receiving end, these frequencies are separated and the differences in time of arrival are measured. Doren Mitchell, assigned to A. T. & T. Co. No. 1,784,194.

Voice-control circuit. Voice-frequency amplifier, containing a circuit for determining the effectiveness of transmission in response to voice frequencies plus a method of reducing cross-talk by discriminating against voice frequencies high in energy content. Allen Carpe, assigned to A. T. & T. Co. No. 1,784,178.

Carrier system equalizer. Transmitting over the line several pilot frequencies in sequence, separating these frequencies at the receiving end, and producing gain or loss desired by means of this pilot frequency. Allen Carpe, assigned to A. T. & T. Co. No. 1,784,176.

Reflex amplifier. A vacuum tube amplifier arranged in a given stage to amplify both radio frequencies and audio frequencies. E. H. Loftin, assigned to Radio Corporation of America. No. 1,784,150.

Submarine signalling. Apparatus for determining the direction of a sound comprising spaced receivers responsive to sound, made for operating the visual indicators by the action of the receiver. R. G. Fay, and H. E. Dorsey, assigned to Submarine Signal Corp., Boston, Mass. No. 1,784,137.

Repeater circuit. Receiving highly attenuated current by equalizing the intensity of the received current to different frequencies at low energy level, amplifying the equalized current uniformly and thereafter restoring the frequency distribution of energy to normal. H. W. Dudley, assigned to B.T.L. Inc. No. 1,784,825.

Signalling system. A combination of 2-way signalling, and a receiver. J. F. Farrington, assigned to W. E. Co., Inc. No. 1,784,867.

Private signalling system. A secret communication system, in which two paths are provided for transmitting the upper and lower portions of the one side-band of a modulated carrier. In each path, a means is provided for demodulating to the original frequency range, with the two portions adjacent transposed and continually varying. S. W. Dean, and C. N. Anderson, assigned to A. T. & T. Co. No. 1,784,891.

Regenerative circuit. A regenerative circuit in which a direct anode potential is connected in parallel with a regeneratively coupled anode inductance. Manfred von Ardenne and H. Heinert, Berlin, Germany, assigned to RCA. No. 1,784,857.

Radio receiver. This is the familiar "Betts" circuit, in vogue among experimenters of a few years ago. The inter-stage transformer between first and second tubes in a radio receiver is an auto-transformer divided into three approximately equal parts. One of the two parts is used as a primary, while the voltage across the two halves is applied to the following tubes. Neutralization is secured by going into the center of the input circuit of the second tube. Regeneration may be applied, also. C. H. Betts, assigned to W. E. Co., Inc. No. 1,784,957.

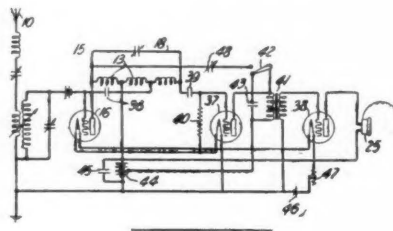

Portable radio apparatus. On the steering column of an automobile is the radio control apparatus. W. M. Heina, assigned to Automobile Radio Corp. No. 1,785,552.

Vacuum Tube Manufacture

De-gassing. A method of de-gassing a vacuum tube consisting in raising the temperature of the metals inside the glass wall to a high point, while maintaining the glass below the melting temperature, by means of induction. F. S. McCullough, Wilkesburg, Pa. No. 1,787,082.

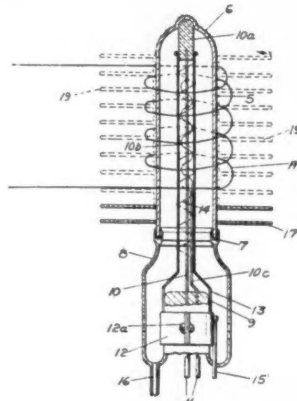

Facsimile transmission. A scanning system apparently using a cathode-ray tube. C. K. Zworykin, assigned to Westinghouse E. & M. Co. No. 1,786,812.

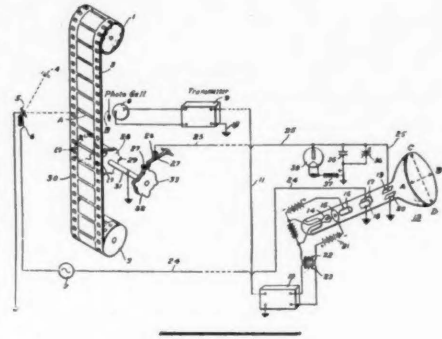

Picture Transmission, Television, Etc.

Picture transmission. Between two successive lines as scanned by the usual method, a means is provided for continually changing the frequency of the transmitted carrier. Fritz Schröeter, Berlin, Germany. Assigned to Gesellschaft für Drahtlose Telegraphie. No. 1,784,850.

Duplex scanning disk. A scanning disk of the lens type. Charles F. Jenkins, assigned to Jenkins Laboratories. No. 1,785,262.

Electro-optical system. Image producing system, comprising means of successively scanning groups of elemental areas of an image, each group composed of two separate areas scanned simultaneously, and then combined into a single photo-electric current. R. V. L. Hartley, assigned to B.T.L. Inc. No. 1,786,652.

Picture transmission. A scanning and reproducing system in which a screen provides a small opening through which small areas of light-sensitive measures are exposed, surrounding a light-sensitive cell. Charles A. Hoxie, assigned to G. E. Co. No. 1,787,273.

Miscellaneous

Gaseous tube relay. Relay in plate circuit of gas content tube operates when grid voltage is adjusted so that ionization of gas occurs. Floyd Firestone assigned to Regents of University of Michigan. No. 1,783,234.

Remote control system. Gas tube operates a relay when a high frequency incoming signal raises tube voltage above ionizing point. H. E. Allen, assigned to G.E. Co. No. 1,783,820.

Remote control relay system. System using vacuum tube in which various intervals of time operate relays in various manners. L. E. Bird, assigned to G.E. Co. No. 1,783,900.

Distortion compensator. Non-linearity between input and output of amplifier circuit is compensated by feeding into the input sufficient of the output to promote linearity. Thus distortion is eliminated. Joseph Bethenod, Paris, France. No. 1,783,557.

Picture transmission. Means for obtaining suitable relation between quantity of light incident on light-sensitive element and output current of vacuum tube amplifier. Allan Weaver, assigned to A.T. & T. Co. No. 1,783,321.

TUBES and CONTROL

"Turn that music down."

Paterfamilias isn't a bit interested in those lively dance tunes that set the toes of the junior members of the family tingling. He's reading an interesting detective story.

So Mary turns the volume control and that same music comes in, undistorted, but less loud.

Here at CENTRALAB our engineers have spent years in perfecting a control that enables a million "Marys" to tune their radio receivers from a mere scarcely audible whisper to volume sufficient to fill a hall. It's a delicate, exacting business, this building of volume controls to suit the definite requirements of scores of set manufacturers.

That we have been successful is evidenced by the fact that we have built more than twenty million CENTRALAB controls within a few short years. The world's leading manufacturers still unhesitatingly recommend and specify "CENTRALAB."

If you have a resistance problem
our engineering staff is at your service
Send 25c. for Volume Control Guide showing circuits
for old and new sets.

New T Type Volume
Controls are ready.
Write for special
Bulletin portraying
curves and graphs of
performance of these
controls in sound
projection.

Centralab

CENTRAL
RADIO
LABORATORIES

■ 16 KEEFE AVENUE, MILWAUKEE, WISCONSIN ■

Variable-mu tetrodes

[Continued from page 473]

input voltage under measurement which is desirable.

A number of modifications of this method may be employed. For example, while it is possible to cover a range of 1000:1 with one exponential tube, it is often preferable to employ two or three, with suitable graduation of the biases among them. In this way slight departures from an exact exponential characteristic of

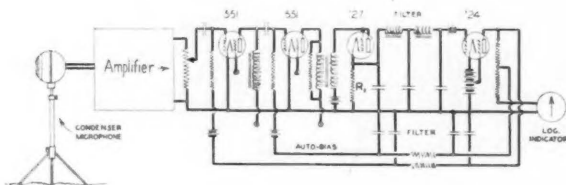

Fig. 4—Diagram of logarithmic indicator for use in automatic recording of sound-pressure frequency characteristics of loud-speakers

one tube may often be compensated for by opposite departures in another. Different parts of the characteristics of the several tubes may be superposed by proper choice of initial (fixed) biases and rates of auto control.

Two important applications of this method have been made: (1) to automatic and manual recorders of radio field-strength; and (2) to automatic recorders of sound-pressure for frequency-response measurements of loud-speakers.

Radio field-strength recording

Logarithmic records of radio signal intensity are useful in the study of transmission and fading or in connection with surveys of the distribution of signal voltages among the channels in the broadcast band at a given receiver location and at a given time. Such signal strength surveys have been found useful by Radio Frequency Laboratories in statistical studies of the requirements of sensitivity, selectivity and image response in broadcast receivers. The range ordinarily required in this work is quite large, and of the order of 100,000 to 1,000,000. The lower limit of the attainable range is usually fixed by fluctuation-noise (thermal and shot-effects), and the upper limit by the voltage which can be applied to the tubes without distortion. The Type 551 tubes were originally developed to reduce distortion and are capable of handling voltages of the

order of 10 times those which overload ordinary 24 type tubes. For accurate logarithmic indication the upper input voltage limit with the exponential Type 551 tetrode is about one volt. At the lower end of the range satisfactory automatic control can be easily obtained down to the fluctuation-noise limit, which lies between 10^{-6} and 10^{-5} volts. Satisfactory logarithmic recording is therefore possible over a considerable range of signal intensities.

Frequency-response recording

Automatic recording on logarithmic scales of amplitude and frequency is particularly useful in the study of the frequency-response characteristics of loud-speakers. The usual point-by-point method of obtaining these characteristics is inaccurate and time-consuming. The response of the ear is logarithmic and a logarithmic scale of ordinates is almost a logical necessity in work of this character. The range of amplitudes required is moderate, 100 to 1000 being adequate. The connections of a logarithmic recorder developed for this purpose are shown in Fig. 4.

The sound is picked up by means of the precision spherical condenser microphone *M*. The electrical output is amplified and applied to the first exponential 551 tube after proper adjustment by the attenuator. The diode *d* serves as a rectifier. The output of the diode appears across R_1 and the a.c. components are largely suppressed in the following low-pass filter. The final tube serves as a d.c. amplifier. Its output is again filtered and serves to bias the two 551 exponential tubes. In this case the bias on the two tubes is graduated, that on the second tube being varied at the slower rate. The final ammeter *a* serves as the indicating instrument. If the d.c. amplifier tube carries a small steady plate current in the quiescent state this can be balanced out in the ammeter by the usual bucking arrangement.

The arrangement of the automatic sound-pressure recorder is the usual one. A variable condenser connected in the circuit of an audio beat frequency oscillator and having plates so shaped as to produce a logarithmic variation of frequency with angular rotation is rotated by a motor. The same shaft operates a platen, carrying a piece of sensitized paper, which moves across a light beam reflected by the galvanometer. A set of coordinates is impressed upon the paper by projection from a photographic plate. The record obtained is logarithmic both in frequency and sound-pressure.

More complete descriptions of these recording instruments will be given elsewhere; in the meantime it is thought that this brief description of the method may be of interest.

Patents—

[Continued from page 488]

Advertising display. A method of scanning an object for purposes of advertising, involves a light-sensitive relay system. A. Abel, Leipzig, Germany. No. 1,787,334.

Current impulse indicator. A system for detecting current impulses impressed on an electrical conductor. The impulses are conveyed to the grid of a vacuum tube and so changes the operation of the

tube that a mechanical counter in the plate circuit is actuated. Otto Lohaus, assigned to Aktiengesellschaft Mix and Genest. No. 1,786,666.

Train control. A system of transmitting high frequency waves along the road-bed of each block of a railway. Traffic is controlled by this apparatus. John Hays Hammond, Jr., Gloucester, Mass. No. 1,786,610.

Power standard device. A composite alternating current of definite power-frequency value is generated by holding a definite resistance at a definite temperature and amplifying the voltage

fluctuation across its terminals due to thermal agitation. Harry Nyquist, assigned to A. T. & T. Co. No. 1,786,546.

Control system. A circuit in which a three-winding transformer, a three-element tube, and accessory apparatus, controls current and voltage. E. F. W. Alexanderson, assigned to G. E. Co. No. 1,787,299.

Electric discharge device. Tube in which the cathode and the heating element are electrically in contact until some current responsive means breaks the contact. E. F. W. Alexanderson, assigned to G. E. Co. No. 1,787,300.