

LOGIC BOARD
 FRASER ELECTRONICS R9 CONTROLLER
 OCT 13 / 80 Rev APR 5 / 85 D. Fraser

MATRIX POWER BOARD

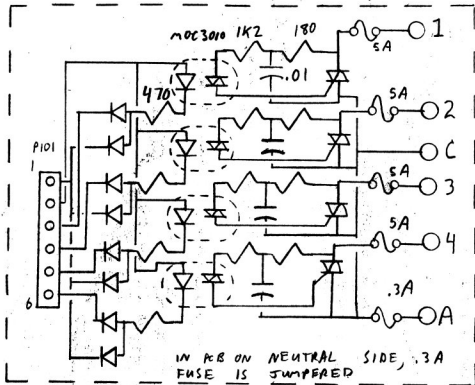

Memory Interchangeability

	745387 1.79	745287 1.79	545387 8	545287	S
AMD.	27510C PC	27511C PC	27510M PC	27511M PC.	
FSC	93416C PC 93417PC - 1.95.	93426M - PC 93427PC. 1.95.	93417M - PC	93426M - PC. (?)	
HARRIS	HM17610-5	HM17611-5	HM17610-2.	HM17611-2	
HARRIS	HPRUM1024A-5	HPRUM1024-5.	HPRUM1024A-2.	HPRUM1024-2	
INTEL.	P3601		Q3601		
INTERNAL CPE SUPPLY	1M5603AC	1M5623C	1M5603AM.	1M5623M	
MMI PREP H63	5201 6201N	H6201N	5201 N	H15201 N	
MMI	6300 N (6300J-1) 1.95	6301 N (6301J-1) 1.95	5300 N	5301 N	
VSC.	DM8573N	DM8574N	DM7573 N	DM7574 N	
SIG	N825126B	N825129B	5825126B	5825129B	
SIG		N825229B.		5825229B.	

PRUM

selection

Guide

AC
12V

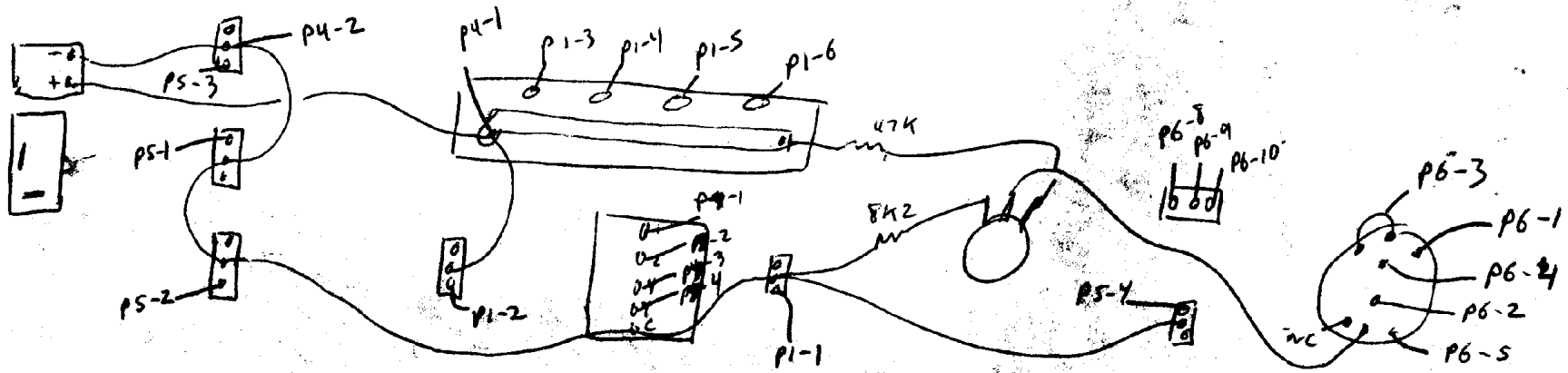

ALL MEASUREMENTS INCLUDE
 THICKNESS OF METAL

HOLES MARKED "A"	@	$\frac{9}{64}$ " DIA	(5 TOTAL)
HOLES MARKED "B"	@	$\frac{3}{32}$ " DIA	(2 TOT)
ALL OTHER HOLES	@	$\frac{3}{16}$ " DIA	(22 TOT)
			<u>29 HOLES TOTAL</u>

SCALE : 1 INCH = 2 DIVISIONS

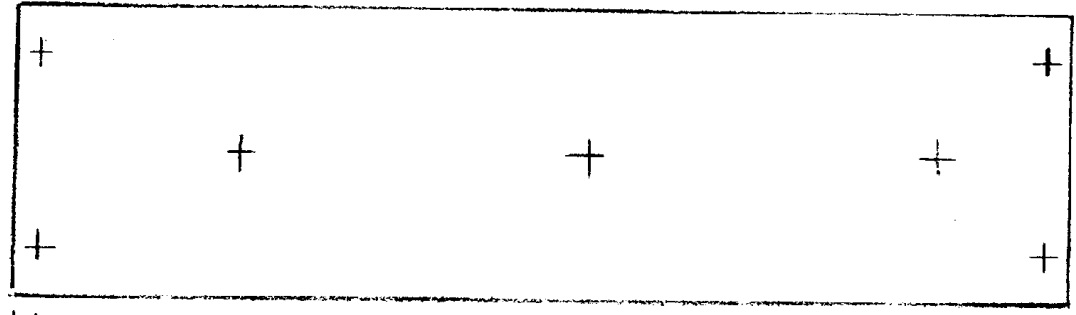
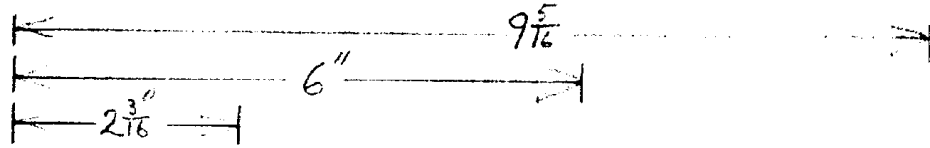
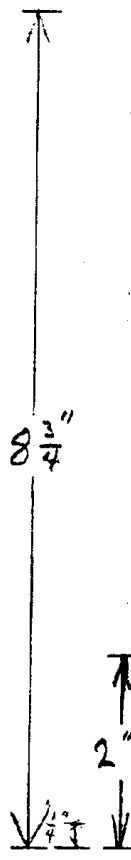
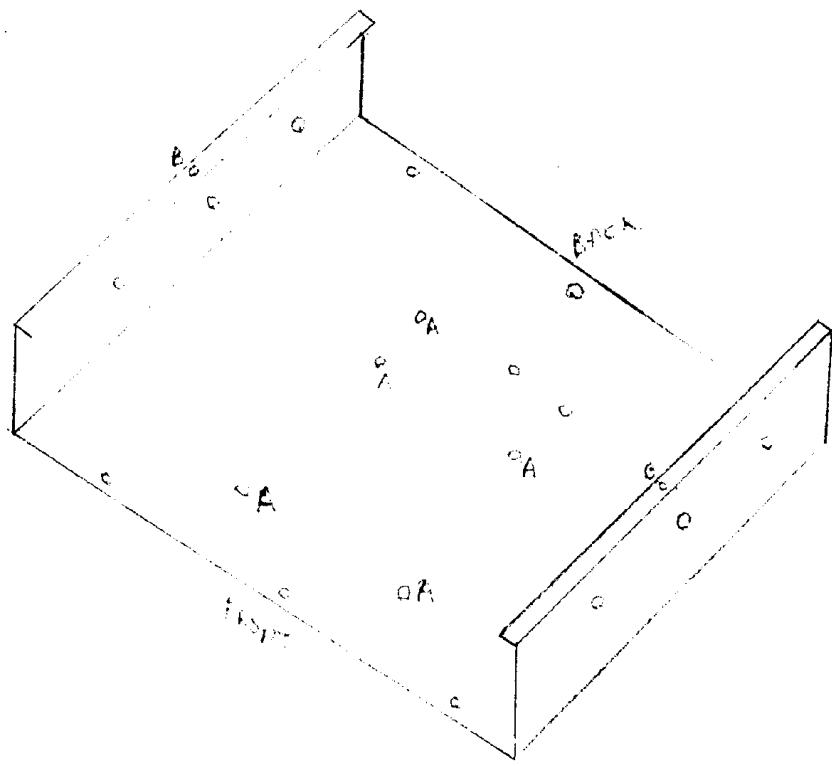

BRON

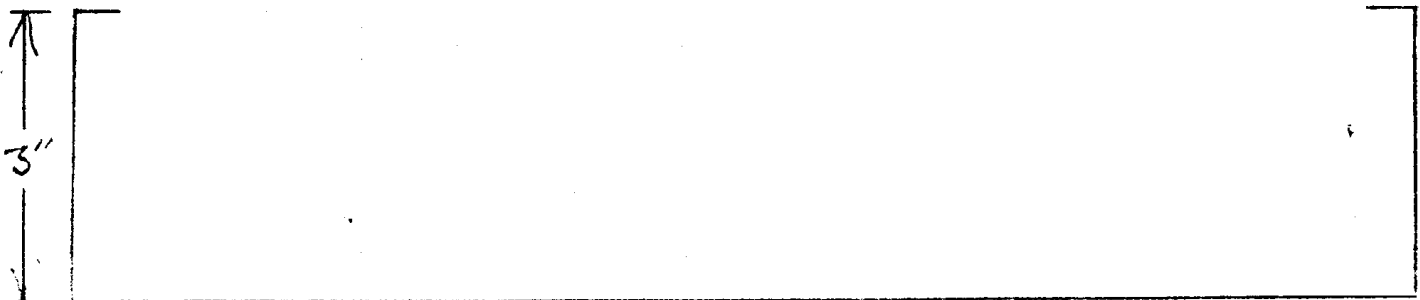
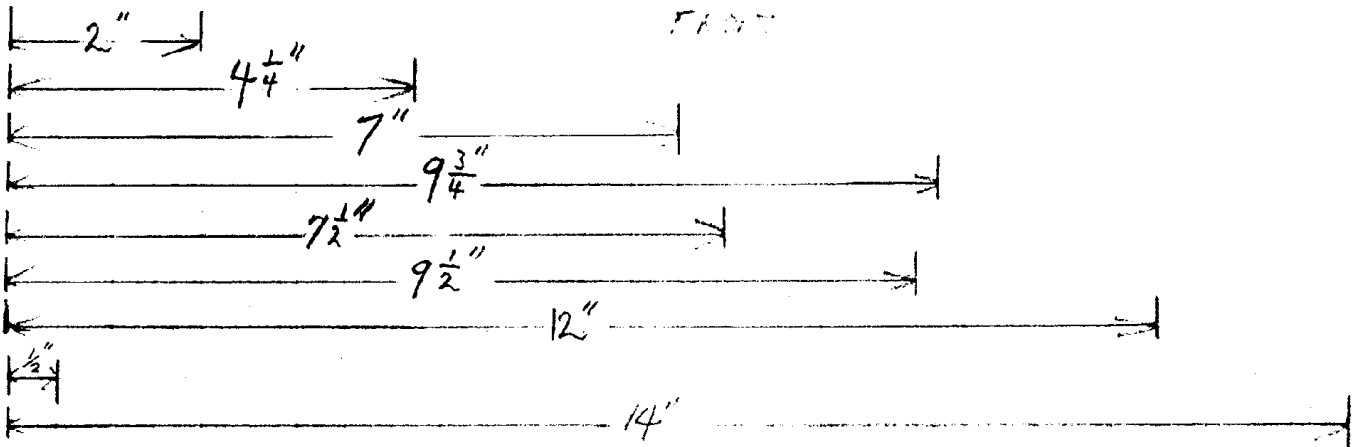
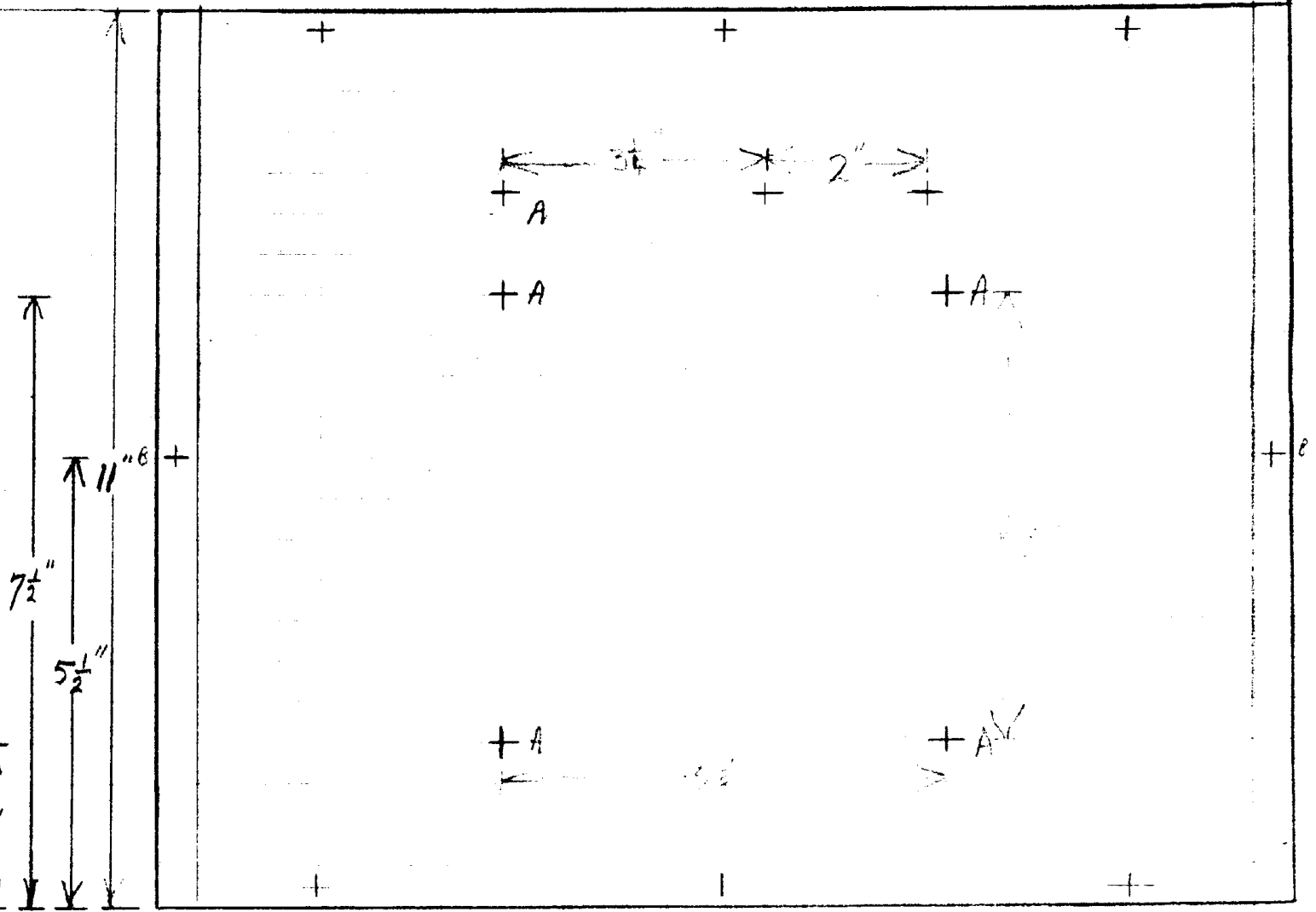

R9 LOGIC BOARD PARTS LAYOUT

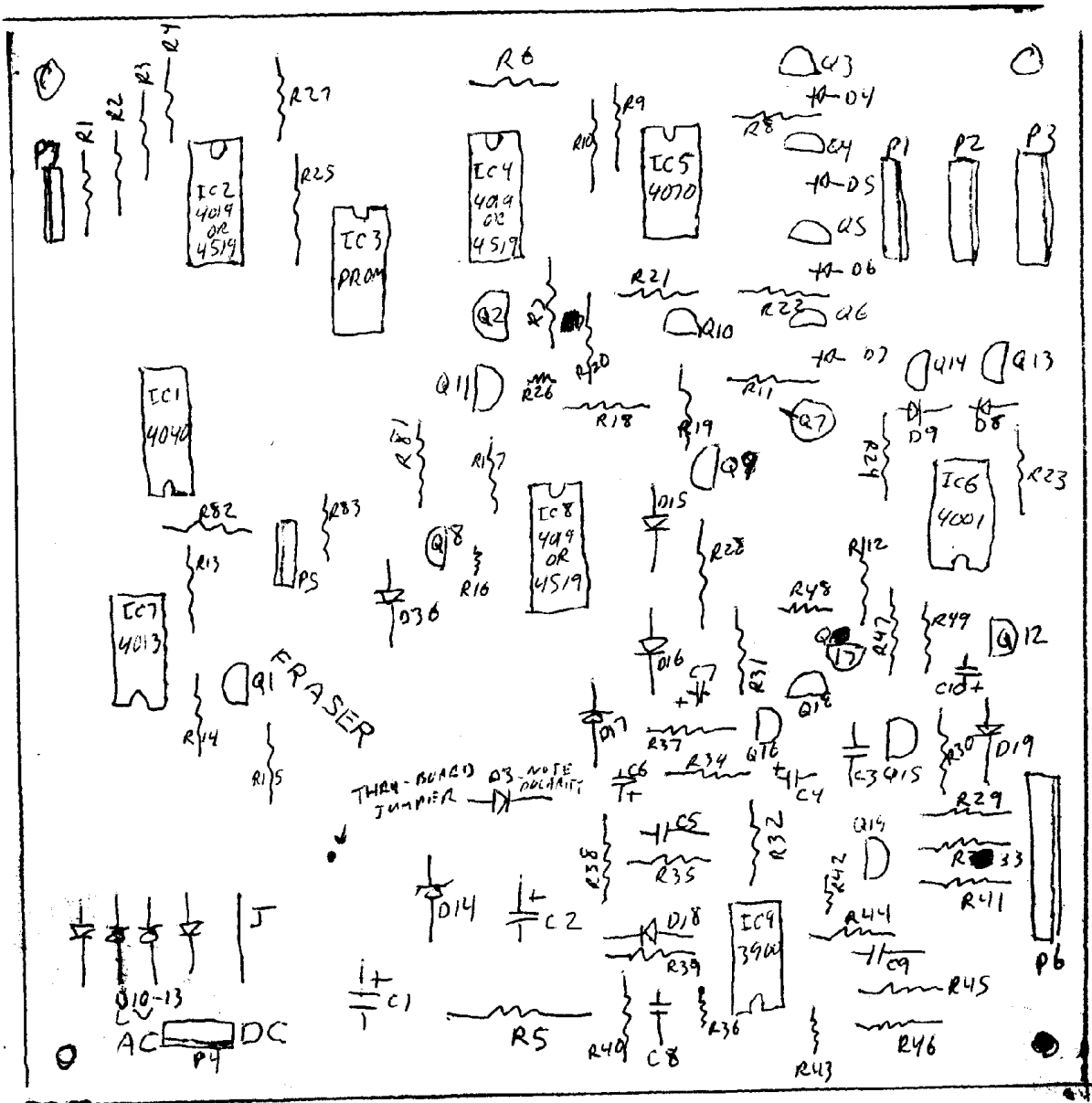

LED BOARDS PWR BOS.

R53-56 R57-80

R52 C11-18

LED 1-5 D20-35

2/23/82

D. From